

## MA 255*i*

Modular interfacing unit for Leuze Ident and  
RS 232 devices on DeviceNet

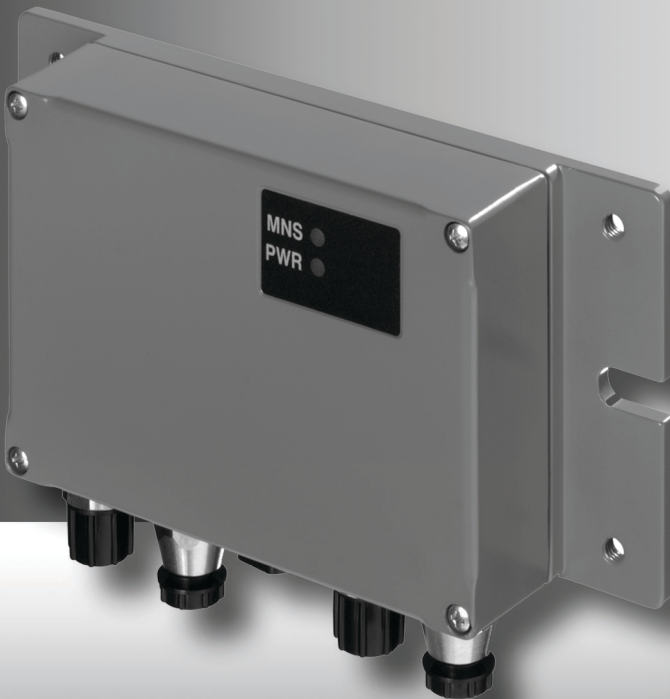

## Sales and Service

### Germany

### Sales Region North

Phone 07021/573-306  
Tel. Int. + 34 93 4097900  
Fax 07021/9850950

Postal code areas  
20000-38999  
40000-65999  
97000-97999

### Sales Region South

Phone 07021/573-307  
Tel. Int. + 34 93 94935820  
Fax 07021/9850911

Postal code areas  
66000-96999

### Sales Region East

Phone 035027/629-106  
Tel. Int. + 381 11 3018 326  
Fax 035027/629-107

Postal code areas  
01000-19999  
39000-39999  
98000-99999

### Worldwide

#### AR (Argentina)

Condelectric S.A.  
Tel. Int. + 54 1148 361053  
Fax Int. + 54 1148 361053

#### AT (Austria)

Schmachtl GmbH  
Tel. Int. + 43 732 7646-0  
Fax Int. + 43 732 7646-785

#### AU + NZ (Australia + New Zealand)

Balluff/Leuze Pty. Ltd.  
Tel. Int. + 61 3 9720 4100  
Fax Int. + 61 3 9738 2677

#### BE (Belgium)

Leuze electronic nv/sa  
Tel. Int. + 32 2253 16-00  
Fax Int. + 32 2253 15-36

#### BG (Bulgaria)

ATICS  
Tel. Int. + 359 2 847 6244  
Fax Int. + 359 2 847 6244

#### BR (Brazil)

Leuze electronic Ltda.  
Tel. Int. + 55 11 5180-6130  
Fax Int. + 55 11 5180-6141

#### CH (Switzerland)

Leuze electronic AG  
Tel. Int. + 41 41 784 5656  
Fax Int. + 41 41 784 5657

#### CL (Chile)

Imp. Tec. Vignola S.A.I.C.  
Tel. Int. + 56 3235 11-11  
Fax Int. + 56 3235 11-28

#### CN (China)

Leuze electronic Trading  
(Shenzhen) Co. Ltd.  
Tel. Int. + 86 755 862 64909  
Fax Int. + 86 755 862 64901

#### CO (Colombia)

Componentes Electronicas Ltda.  
Tel. Int. + 57 4 3511049  
Fax Int. + 57 4 3511019

#### CZ (Czech Republic)

Schmachtl CZ s.r.o.  
Tel. Int. + 420 244 0015-00  
Fax Int. + 420 244 9107-00

#### DK (Denmark)

Leuze electronic Scandinavia ApS  
Tel. Int. + 45 48 173200

#### ES (Spain)

Leuze electronic S.A.  
Tel. Int. + 34 93 4097900  
Fax Int. + 34 93 94935820

#### FI (Finland)

SKS-automatio Oy  
Tel. Int. + 358 20 764-61  
Fax Int. + 358 20 764-6820

#### FR (France)

Leuze electronic Sarl.  
Tel. Int. + 33 160 0512-20  
Fax Int. + 33 160 0503-65

#### GB (United Kingdom)

Leuze electronic Ltd.  
Tel. Int. + 44 14 8040 85-00  
Fax Int. + 44 14 8040 38-08

#### GR (Greece)

UTECO A.B.E.E.  
Tel. Int. + 30 211 1206 900  
Fax Int. + 30 211 1206 999

#### HK (Hong Kong)

Sensortech Company  
Tel. Int. + 852 26510188  
Fax Int. + 852 26510388

#### HR (Croatia)

Tipteh Zagreb d.o.o.  
Tel. Int. + 385 1 381 6574  
Fax Int. + 385 1 381 6577

#### HU (Hungary)

Kvaik Automatika Kft.  
Tel. Int. + 36 1 272 2242  
Fax Int. + 36 1 272 2244

#### ID (Indonesia)

P.T. Jabestindo Mitra Utama  
Tel. Int. + 62 21 92861859  
Fax Int. + 62 21 6451044

#### IL (Israel)

Galoz electronics Ltd.  
Tel. Int. + 972 3 9023456  
Fax Int. + 972 3 9021990

#### IN (India)

M + V Marketing Sales Pvt Ltd.  
Tel. Int. + 91 124 4121623  
Fax Int. + 91 124 434223

#### IT (Italy)

Leuze electronic S.r.l.  
Tel. Int. + 39 02 26 1106-43  
Fax Int. + 39 02 26 1106-40

#### JP (Japan)

C. Illies & Co., Ltd.  
Tel. Int. + 81 3 3443 4143  
Fax Int. + 81 3 3443 4118

#### KE (Kenia)

Profa-Tech Ltd.  
Tel. Int. + 254 20 828095/6  
Fax Int. + 254 20 828129

#### KR (South Korea)

Leuze electronic Co., Ltd.  
Tel. Int. + 82 31 3828228  
Fax Int. + 82 31 3828522

#### MK (Macedonia)

Tipteh d.o.o. Skopje  
Tel. Int. + 389 70 399 474  
Fax Int. + 389 23 174 197

#### MX (Mexico)

Movitren S.A.  
Tel. Int. + 52 81 8371 8616  
Fax Int. + 52 81 8371 8588

#### MY (Malaysia)

Ingermark (M) SDN.BHD  
Tel. Int. + 60 360 3427-88  
Fax Int. + 60 360 3421-88

#### NG (Nigeria)

SABROW HI-TECH E. & A. LTD.  
Tel. Int. + 234 80333 86366  
Fax Int. + 234 80333 84463518

#### NL (Netherlands)

Leuze electronic BV  
Tel. Int. + 31 418 65 35-44  
Fax Int. + 31 418 65 38-08

#### NO (Norway)

Elteco A/S  
Tel. Int. + 47 35 56 20-70  
Fax Int. + 47 35 56 20-99

#### PL (Poland)

Balluff Sp. z o. o.  
Tel. Int. + 48 71 338 49 29  
Fax Int. + 48 71 338 49 30

#### PT (Portugal)

LA2P, Lda.  
Tel. Int. + 351 21 4 447070  
Fax Int. + 351 21 4 447075

#### RO (Romania)

O BOYLE s.r.l.  
Tel. Int. + 40 2 56201346  
Fax Int. + 40 2 56221036

#### RS (Republic of Serbia)

Tipteh d.o.o. Beograd  
Tel. Int. + 381 11 3131 057  
Fax Int. + 381 11 3018 326

#### RU (Russian Federation)

ALL IMPEX 2001  
Tel. Int. + 7 495 9213012  
Fax Int. + 7 495 6462092

#### SE (Sweden)

Leuze electronic Scandinavia ApS  
Tel. Int. + 46 380 490951

#### SG + PH (Singapore + Philippines)

Balluff Asia Pte Ltd  
Tel. Int. + 65 6252 43-84  
Fax Int. + 65 6252 90-60

#### SI (Slovenia)

Tipteh d.o.o.  
Tel. Int. + 386 1200 51-50  
Fax Int. + 386 1200 51-51

#### SK (Slovakia)

Schmachtl SK s.r.o.  
Tel. Int. + 421 2 58275600  
Fax Int. + 421 2 58275601

#### TH (Thailand)

Industrial Electrical Co. Ltd.  
Tel. Int. + 66 2 642 6700  
Fax Int. + 66 2 642 4250

#### TR (Turkey)

Leuze electronic San ve Tic.Ltd.Siti.  
Tel. Int. + 90 216 456 6704  
Fax Int. + 90 216 456 3650

#### TW (Taiwan)

Great Colvue Technology Co., Ltd.  
Tel. Int. + 886 2 2983 80-77  
Fax Int. + 886 2 2985 33-73

#### UA (Ukraine)

SV Altera OOO  
Tel. Int. + 38 044 4961888  
Fax Int. + 38 044 4961818

#### US + CA (United States + Canada)

Leuze electronic, Inc.  
Tel. Int. + 1 248 486-4466  
Fax Int. + 1 248 486-6699

#### ZA (South Africa)

Countapulse Controls (PTY).Ltd.  
Tel. Int. + 27 116 1575-56  
Fax Int. + 27 116 1575-13

<b>1</b>	<b>General information</b> .....	<b>6</b>
1.1	Explanation of symbols .....	6
1.2	Declaration of conformity .....	6
1.3	Description of functions .....	7
1.4	Definition of Terms .....	8
<b>2</b>	<b>Safety notices</b> .....	<b>9</b>
2.1	General safety notices .....	9
2.2	Safety standards .....	9
2.3	Intended use .....	9
2.4	Working safely .....	10
<b>3</b>	<b>Fast commissioning / operating principle</b> .....	<b>11</b>
3.1	Mounting .....	11
3.2	Device arrangement and selection of the mounting location .....	11
3.3	Electrical connection .....	11
3.3.1	Connecting the Leuze device .....	12
3.3.2	Setting the DeviceNet device address .....	12
3.3.3	Setting the DeviceNet baud rate .....	13
3.3.4	Connecting the power supply and the bus cable .....	13
3.4	Starting the device .....	14
3.5	MA 255 <i>i</i> on the DeviceNet .....	14
<b>4</b>	<b>Device description</b> .....	<b>15</b>
4.1	General Information to the connector units .....	15
4.2	Characteristics of the connector units .....	15
4.3	Device construction .....	16
4.4	Operating modes .....	17
4.5	Fieldbus systems .....	18
4.5.1	DeviceNet .....	18
<b>5</b>	<b>Specifications</b> .....	<b>21</b>
5.1	General specifications .....	21
5.2	Dimensioned drawings .....	22
5.3	Type overview .....	23

<b>6</b>	<b>Installation and mounting</b>	<b>24</b>
6.1	Storage, transportation	24
6.2	Mounting	25
6.3	Device arrangement	26
6.3.1	Selecting a mounting location	26
6.4	Cleaning	26
<b>7</b>	<b>Electrical connection</b>	<b>27</b>
7.1	Safety notices for the electrical connection	27
7.2	Electrical connection	28
7.2.1	PWR IN – voltage supply / switching input/output	28
7.2.2	PWR OUT switching input/output	30
7.3	BUS IN	30
7.4	BUS OUT	31
7.4.1	Termination of the DeviceNet	31
7.5	Device interfaces	32
7.5.1	RS 232 device interface (accessible after opening the device, internal)	32
7.5.2	Service interface (internal)	33
<b>8</b>	<b>Status displays and operational controls</b>	<b>34</b>
8.1	LED status indicators	34
8.1.1	LED indicators on the circuit board	34
8.1.2	LED indicators on the housing	35
8.2	Internal interfaces and operational controls	36
8.2.1	Overview of operational controls of the	36
8.2.2	Connector X30 ... connectors	38
8.2.3	RS 232 service interface – X33	38
8.2.4	S10 service switch	38
8.2.5	Rotary switch S4 for device selection	39
8.2.6	Switch for address selection in the fieldbus	40
8.2.7	Switch for setting the baud rate	40
<b>9</b>	<b>Configuration</b>	<b>41</b>
9.1	Connecting the service interface	41
9.2	Reading out information in service mode	41

<b>10</b>	<b>Telegram</b> .....	<b>44</b>
10.1	Structure of the fieldbus telegram .....	44
10.2	Description of the input bytes (status bytes) .....	45
10.2.1	Structure and meaning of the input bytes (status bytes) .....	45
10.2.2	Detailed description of the bits (input byte 0) .....	46
10.2.3	Detailed description of the bits (input byte 1) .....	48
10.3	Description of the output bytes (control bytes) .....	48
10.3.1	Structure and meaning of the output bytes (control bytes) .....	48
10.3.2	Detailed description of the bits (output byte 0) .....	49
10.3.3	Detailed description of the bits (output byte 1) .....	50
10.4	RESET function / deleting memory .....	51
<b>11</b>	<b>Modes</b> .....	<b>52</b>
11.1	Functionality of the data exchange .....	52
11.1.1	Reading slave data in Collective mode (gateway -> PLC) .....	53
11.1.2	Writing slave data in Collective mode (PLC -> gateway) .....	53
11.1.3	Command mode .....	56
<b>12</b>	<b>Commissioning and configuration</b> .....	<b>59</b>
12.1	Measures to be performed prior to the initial commissioning .....	59
12.2	Starting the device .....	61
12.3	Configuration steps for a Rockwell control .....	61
12.3.1	Setting the hardware configuration .....	61
12.3.2	Installation of the EDS file .....	63
12.3.3	Setting the parameters on the MA .....	63
12.4	EDS file - general info .....	64
12.5	EDS file - detailed description .....	66
12.5.1	Class 1 Identity object .....	66
12.5.2	Class 15 parameter object .....	68
12.6	Setting the read parameters on the Leuze device .....	72
12.6.1	Specific feature for the use of hand-held scanners (bar code and 2D devices, combi devices with RFID) .....	73
12.6.2	Specific features in the operation of an RFM/RFI .....	74
<b>13</b>	<b>Diagnostics and troubleshooting</b> .....	<b>75</b>
13.1	General causes of errors .....	75
13.2	Interface errors .....	76

<b>14</b>	<b>Type overview and accessories</b> .....	<b>77</b>
14.1	Type key .....	77
14.2	Type overview .....	77
14.3	Accessory terminating resistor .....	77
14.4	Accessory connectors .....	77
14.5	Accessory ready-made cables for voltage supply .....	78
14.5.1	Contact assignment of PWR connection cable .....	78
14.5.2	Specifications of the cables for voltage supply .....	78
14.5.3	Order codes of the cables for voltage supply .....	79
14.6	Accessory ready-made cables for bus connection .....	79
14.6.1	General information .....	79
14.6.2	Contact assignment of M12-DeviceNet connection cable KB DN... ..	79
14.6.3	Specifications of M12-DeviceNet connection cable KB DN... ..	80
14.6.4	Order codes of M12-DeviceNet connection cable KB DN... ..	80
14.7	Accessory ready-made cables for connecting Leuze ident devices .....	81
14.7.1	Order codes for the device connection cables .....	81
14.7.2	Contact assignment for the device connection cables .....	81
<b>15</b>	<b>Maintenance</b> .....	<b>82</b>
15.1	General maintenance information .....	82
15.2	Repairs, servicing .....	82
15.3	Disassembling, packing, disposing .....	82
<b>16</b>	<b>Specifications for Leuze end devices</b> .....	<b>83</b>
16.1	Standard setting, KONTURflex (S4 switch position 0) .....	83
16.2	Bar code reader BCL 8 (S4 switch position 1) .....	85
16.3	Bar code reader BCL 22 (S4 switch position 2) .....	86
16.4	Bar code reader BCL 32 (S4 switch position 3) .....	87
16.5	Bar code reader BCL 300i, BCL 500i (S4 switch position 4). .....	88
16.6	Bar code reader BCL 90 (S4 switch position 5) .....	89
16.7	LSIS 122 (S4 switch position 6) .....	90
16.8	LSIS 4x2i (S4 switch position 7) .....	91
16.9	Hand-held scanner (S4 switch position 8) .....	92
16.10	RFI, RFM, RFU RFID readers (S4 switch position 9) .....	93
16.11	BPS 8 bar code positioning system (S4 switch position A) .....	94

---

16.12	AMS distance measurement device, ODSL xx optical distance sensors with RS 232 interface (S4 switch position B) . . . . .	95
16.13	Modular interfacing unit MA 3x (S4 switch position C) . . . . .	97
16.14	Resetting the parameters (S4 switch position F) . . . . .	98
<b>17</b>	<b>Appendix. . . . .</b>	<b>99</b>
17.1	ASCII table . . . . .	99

## 1 General information

### 1.1 Explanation of symbols

The symbols used in this operating manual are explained below.



**Attention!**

*This symbol precedes text messages which must strictly be observed. Failure to comply with this information results in injuries to personnel or damage to the equipment.*



**Notice!**

*This symbol indicates text passages containing important information.*

### 1.2 Declaration of conformity

The MA 255*i* modular interfacing units have been designed and manufactured in accordance with applicable European directives and standards.



**Notice!**

*The Declaration of Conformity for these devices can be requested from the manufacturer.*

The manufacturer of the product, Leuze electronic GmbH + Co. KG in D-73277 Owen, possesses a certified quality assurance system in accordance with ISO 9001.





### 1.3 Description of functions

The MA 255*i* modular interfacing unit is used to connect Leuze devices directly to the fieldbus.

Bar code reader:	BCL 8, 22, 32, 300i, 500i, 90
2D code reader:	LSIS 122, LSIS 4x2i
Hand-held scanner	ITxxxx, HFU/HFM
RFID read-write devices:	RFM 12, 32, 62 & RFI 32, RFU 61, 81
Bar code positioning system:	BPS 8
Distance measurement device:	AMS 200
Optical distance sensors:	ODSL 9, ODSL 30, ODSL 96B
Measuring light curtain:	KONTURflex to Quattro-RSX/M12
MultiNet master connection box:	MA 3x
Additional RS 232 devices:	Scales, third-party devices

This is accomplished by transmitting the data from the DEV via an RS 232 (V.24) interface to the MA 255*i* where a module converts it into the DeviceNet format. The data format on the RS 232 interface corresponds to the Leuze standard data format (9600bd, 8N1 and STX, data, CR, LF).

The integration of the EDS file in the hardware manager of the PLC is necessary to ensure the correct function of the MA 255*i*.

The corresponding Leuze devices are selected using a rotary code switch on the circuit board of the connector unit. Many additional RS 232 devices can be connected through a universal position.

## 1.4 Definition of Terms

For better understanding of the explanations provided in this document, a definition of terms follows below:

- **Bit designation:**

The 1st bit or byte begins with count number "0" and means bit/byte 2<sup>0</sup>.

- **Data length:**

Size of a valid, continuous data packet in bytes.

- **EDS file (electronic data sheet):**

Description of the device for the control.

- **Consistent:**

Data which belongs together with regard to content and which must not be separated is referred to as consistent data. When identifying objects, it must be ensured that the data is transmitted completely and in the correct order, otherwise the result is falsified.

- **Leuze device (DEV):**

Leuze devices, e.g., bar code readers, RFID readers, VisionReader...

- **Online command:**

These commands refer to the respective, connected ident device and may be different depending on the device. These commands are not interpreted by the MA 255*i*, but are instead transmitted transparently (see description of ident device).

- **CR:**

Cross reference.

- **Perspective of I/O data in the description:**

Output data is data which is sent by the control to the MA. Input data is data which is sent by the MA to the control.

- **Toggle bits:**

- **Status toggle bit**

Each change of state indicates that an action was performed, e.g., bit ND (New Data): each change of state indicates that new received data was transmitted to the PLC.

- **Control toggle bit**

An action is performed on each change of state, e.g., bit SDO: on each change of state, the registered data is sent by the PLC to the MA 255*i*.

## 2 Safety notices

### 2.1 General safety notices

#### ***Documentation***

All entries in this technical description must be heeded, in particular those in section "Safety notices". Keep this technical description in a safe place. It should be available at all times.

#### ***Safety regulations***

Observe the locally applicable legal regulations and the rules of the employer's liability insurance association.

#### ***Repair***

Repairs must only be carried out by the manufacturer or an authorized representative.

### 2.2 Safety standards

The devices of the series MA 2xx*i* were developed, manufactured and tested in accordance with the applicable safety standards. They correspond to the state of the art.

### 2.3 Intended use



#### ***Attention!***

*The protection of personnel and the device is guaranteed only if the device is operated in a manner corresponding to its intended use.*

#### ***Areas of application***

The MA 255*i* modular interfacing unit is used for connecting Leuze devices such as bar code- or 2D code readers, hand-held scanners, RFID read-write devices, etc. directly to the fieldbus. A detailed list can be found in "Description of functions" on page 7.

## 2.4 Working safely

**Attention!**

*Access to or changes on the device, except where expressly described in this operating manual, are not authorized.*

**Safety regulations**

Observe the locally applicable legal regulations and the rules of the employer's liability insurance association.

**Qualified personnel**

Mounting, commissioning and maintenance of the device must only be carried out by qualified personnel.

Electrical work must be carried out by a certified electrician.

### 3 Fast commissioning / operating principle



**Notice!**

Below you will find a **short description for the initial commissioning** of the DeviceNet gateway MA 255*i*. Detailed explanations for the listed points can be found throughout the handbook.

#### 3.1 Mounting

The gateway mounting plate MA 255*i* can be mounted in two different ways:

- using four threaded holes (M6) or
- using two M8x6 screws on the two lateral grooves.

#### 3.2 Device arrangement and selection of the mounting location

Ideally, the MA 255*i* should be mounted so that it is easily accessible near the ident device in order to ensure good operability, e.g., for configuring the connected device.

**Detailed information can be found in chapter 6.3.1.**

#### 3.3 Electrical connection

The devices from the MA 2xx*i* family feature four M 12 connectors/sockets which are coded differently depending on the interface.

The voltage supply (**PWR IN**) as well as the switching inputs/outputs (**PWR OUT** or **PWR IN**) are connected there. The number and function of the switching inputs/outputs is dependent on the connected end device.

An internal RS 232 interface is used for connecting the respective Leuze device. Another internal RS 232 interface functions as a service interface for configuring the connected device via a serial null modem cable.

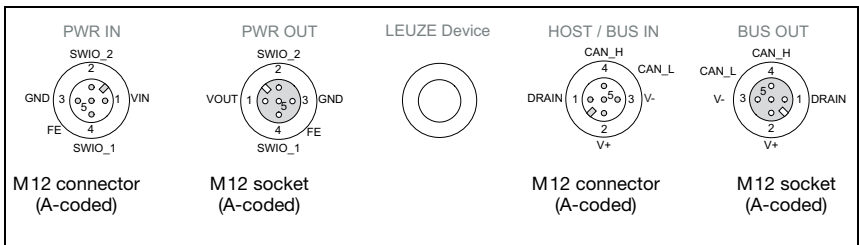

Figure 3.1: MA 255*i* connections

**Detailed information can be found in chapter 7.**

### 3.3.1 Connecting the Leuze device

- ↳ To connect the Leuze device to the internal RS 232 device interface, open the housing of the MA 255*i* and guide the corresponding device cable (see chapter 14.7, e.g., KB 031 for BCL 32) through the middle threaded opening.
- ↳ Connect the cable to the internal device interface (**X30**, **X31** or **X32**, see chapter 7.5.1).
- ↳ Use rotary switch **S4** (see chapter 8.2.5) to select the connected device.
- ↳ Now screw the PG cable gland into the threaded opening to provide strain relief and ensure protection class IP 65.

### 3.3.2 Setting the DeviceNet device address

- ↳ Set the station address of the gateway using the two rotary switches **S1** and **S2** (ones and tens places).

**Notice!**

The DeviceNet permits an address range from 0 to 63. Other addresses must not be used for data communication.

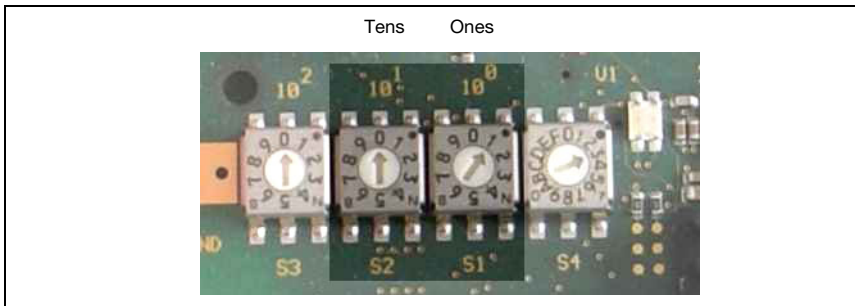

Figure 3.2: Rotary switch for setting the address

### 3.3.3 Setting the DeviceNet baud rate

↪ Set the baud rate of the gateway via the **S3** rotary switch to the value defined in the control.



#### **Notice!**

The DeviceNet baud rate is defined for the entire network in the planning tool/control. The baud rate is set on the MA 255*i* via the baud rate selector switch. Only if the baud rates are the same is communication with the MA 255*i* possible.

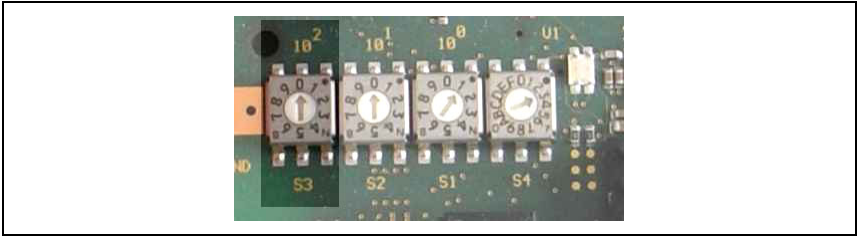

Figure 3.3: Rotary switch for setting baud rate

↪ Finally, close the housing of the MA 255*i*.



#### **Attention!**

Only then may the supply voltage be applied.

Upon startup of the MA 255*i*, the device selection switch and the address settings are queried and the gateway automatically sets itself to the Leuze device.

#### **Connecting functional earth FE**

↪ Ensure that the functional earth (FE) is connected correctly.

Unimpaired operation is only guaranteed when the functional earth is connected properly. All electrical disturbances (EMC couplings) are discharged via the functional earth connection.

### 3.3.4 Connecting the power supply and the bus cable

↪ Ideally, use the ready-made cables listed in chapter 14.5.3 to connect the gateway to the power supply via the **PWR IN** connection.

↪ The ready-made cables listed in chapter 14.6.4 are preferred for connecting the gateway to the fieldbus via the **HOST / BUS IN** connection.

↪ If applicable, use the **BUS OUT** connection if you would like to construct a network with linear topology.

### 3.4 Starting the device

↳ Apply the supply voltage +18 ... 30VDC (+24VDC model).

The MA 255*i* starts up; the PWR LED displays that it is ready for operation.

### 3.5 MA 255*i* on the DeviceNet

↳ Install the EDS file corresponding to the MA 255*i* in your planning tool/the control (e.g., RSNetWorx DeviceNet).



#### **Notice!**

You can find the EDS file at:

**[www.leuze.com](http://www.leuze.com) -> Download -> identify -> Modular interfacing units.**

The MA 255*i* is configured in the planning tool/control by means of the EDS file. The MA 255*i* is assigned an address in the planning tool, which then has to be set in the MA 255*i* via the S1 and S2 address switches. Only if the addresses are the same between the MA 255*i* and the control can communication be established.

After all parameters have been set in the planning tool/control, the download to the MA 255*i* takes place. The set parameters are now stored on the MA 255*i*.

Afterwards, all MA 255*i* parameters should be stored via upload in the control. This aids in retaining the parameters during device exchanges, as they are now also stored centrally in the control.

The DeviceNet baud rate is defined for the entire network in the planning tool/control. The baud rate is set on the MA 255*i* via the S3 baud rate selector switch.

Only if the baud rates are the same is communication with the MA 255*i* possible.

**Detailed information can be found in chapter 12.**



## 4 Device description

### 4.1 General Information to the connector units

The modular interfacing unit of the MA 2xx*i* family is a versatile gateway for integrating Leuze RS 232 devices (e.g., BCL 22 bar code readers, RFID devices, RFM 32, AMS 200) in the respective fieldbus. The MA 2xx*i* gateways are intended for use in industrial environments with a high protection class. Various device versions are available for the conventional fieldbuses. With a stored parameter structure for the connectable RS 232 devices, commissioning could hardly be simpler.

### 4.2 Characteristics of the connector units

A special characteristic of the MA 255*i* device family are three function modes:

1. Transparent mode  
In this function mode, the MA 255*i* functions as a pure gateway with automatic communication from and to the PLC. Absolutely no special programming by the user is necessary for this purpose. The data is not buffered or stored temporarily, however. Instead, it is "passed on".  
The programmer must make certain to retrieve the data from the input memory of the PLC at the right time, as it is otherwise overwritten by new data.
2. Collective mode  
In this operating mode, data and telegram parts are temporarily stored in the memory (buffer) of the MA and sent to the RS 232 interface or to the PLC in a telegram by means of bit activation. In this mode, however, all communication control must be programmed on the PLC.  
This function mode is helpful, for example, for very long telegrams or when one or more codes with long code lengths are read.
3. Command mode  
With this special operating mode, it is possible to use the first bytes of the data range to transmit predefined commands to the connected device by means of bit activation. For this purpose, device-dependent commands (so-called online commands) are predefined via the device selection switch, see chapter 16 "Specifications for Leuze end devices".

### 4.3 Device construction

The MA 255*i* modular interfacing unit is used for interconnecting Leuze devices, such as the BCL 8, BCL 22, etc., directly to the fieldbus. This is accomplished by transmitting the data from the Leuze device via an RS 232 (V.24) interface to the MA 255*i* where a module converts it into the fieldbus format. The data format of the RS 232 interface corresponds to the standard Leuze data format.

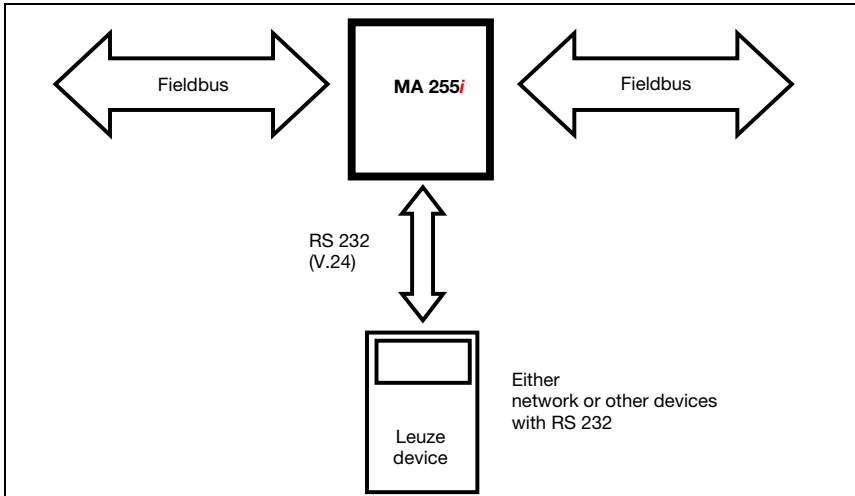

Figure 4.1: Connection of a Leuze devices (BCL, RFI, RFM, VR) to the fieldbus

The cable of the respective Leuze device is guided through cable bushings with PG cable glands into the MA 255*i* and connected there with the PCB connectors.

The MA 255*i* is intended as a gateway for any RS 232 devices, e.g., BCL 90 with MA 90, hand-held scanners, scales or for coupling a multiNet network.

The RS 232 cables are internally connectable using JST plug connectors. The cable can be connected to the device using a stable PG cable gland which provide strain relief and protection against contamination.

With the help of adapter cables with Sub-D 9 or open cable end, other RS 232 devices can also be connected.

## 4.4 Operating modes

For fast commissioning, the MA 255*i* offers an additional operating mode, the "Service mode", in addition to the "Standard mode". In this operating mode, the Leuze device can, for example, be configured on the MA 255*i* and the communication can be tested on the fieldbus. To do this, you need a PC/laptop with a suitable terminal program, as BCL-Config from Leuze or similar.

### Service switch

Select between "operation" and "service" modes with the service switch. You have the following options:

#### Pos. RUN:

##### Operation

The Leuze device is connected to the fieldbus and communicates with the PLC.

#### Pos. DEV:

##### Service Leuze device

The connection between the Leuze device and the fieldbus is interrupted. With this switch position, you can communicate directly with the Leuze device at the fieldbus gateway via RS 232. You can send online commands via the service interface, configure the Leuze device using the corresponding BCL- BPS-, ...-Config configuration software and have the read data of the Leuze device output.

#### Pos. MA:

##### Service fieldbus gateway

With this switch setting, your PC/terminal is connected with the fieldbus gateway. In doing so, the current setting values of the MA (e.g. address, RS 232 parameters) can be called up via a command.

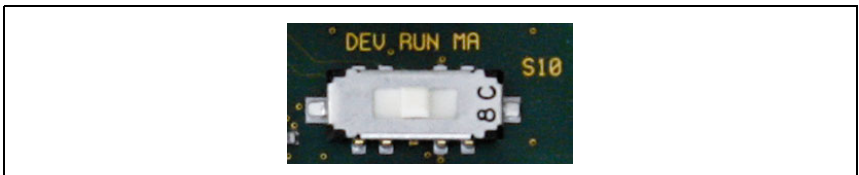

Figure 4.2: Service-switch switch positions



### Notice!

If the service switch is on one of the service settings, the PWR LED flashes on the front side of the device, see chapter 8.1.2 "LED indicators on the housing".

Furthermore, on the control, the SMA service bit of the status bytes signals that the MA is in service mode.

**Service interface**

The service interface can be accessed once the MA 255*i* housing cover has been removed and features a 9-pin Sub-D connector (male). A crossed RS 232 connection cable is required to make the RxD, TxD and GND connections.

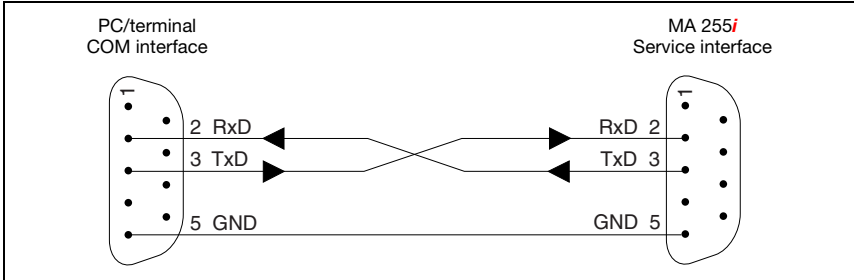

Figure 4.3: Connecting the service interface to a PC/terminal



**Attention!**

For the service PC to function, the RS 232 parameters must be the same as those of the MA. The Leuze standard setting of the interface is 9600bd, 8N1 and STX, data, CR, LF.

**4.5 Fieldbus systems**

Various product variants of the MA 2xx*i* series are available for connecting to different fieldbus systems such as PROFIBUS DP, PROFINET-IO, DeviceNet and Ethernet.

**4.5.1 DeviceNet**

The MA 255*i* is designed as a DeviceNet device with a baud rate of max. 500kBd. The functionality of the device is defined via parameter sets which are clustered in objects, classes and instances. These objects ... are contained in a EDS file.

The MA 255*i* gateways can be operated as network devices on the DeviceNet. The MA 255*i* features multiple M12 connectors / sockets for the electrical connection of the supply voltage, the interface and the switching inputs and outputs. Additional information on the electrical connection can be found in chapter 7.2.

The MA 255*i* supports:

- DeviceNet slave functionality
- CIP profile
- baud rates of 125kBd, 250kBd and 500kBd
- **no** slave address modification via DeviceNet

For further details, see chapter 12!

**Topology**

A bus address is assigned to each participant connected to DeviceNet; this address is represented by a **MAC ID (Media access Identifier)**.

Including the master, up to 64 participants can be connected to one network.

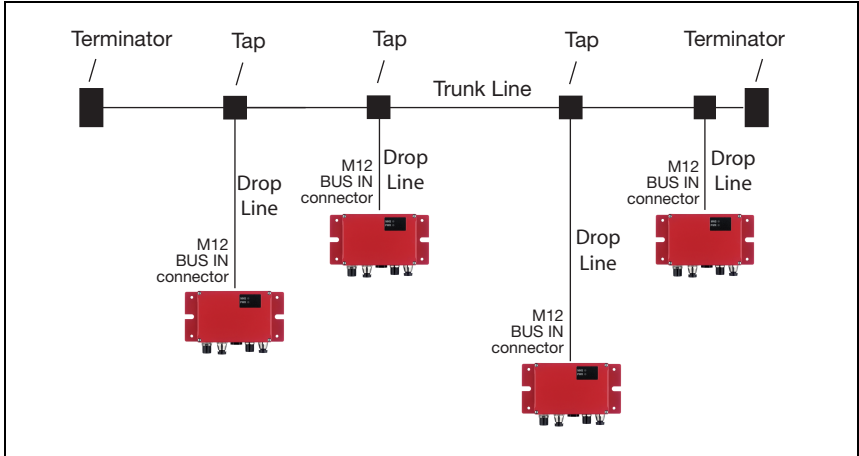

Figure 4.4: Bus topology



**Attention!**

After DeviceNet specification (Volume 3: DeviceNet Adaptation of CIP Chapter 8, Physical Layer 8-3.3 Connectors), use of the BUS OUT connection is not allowed.

The topologies presented here are enabled according to the directives of the ODVA.

It is possible to connect the participants directly to the master line (trunk line) or to the stub cable (drop line) via a tap.

On the respective ends of the trunk line (master line), the bus must be terminated with a 120 ohm terminating resistor. The terminating plug is optional and can be ordered separately (see chapter 14.3 "Accessory terminating resistor").

A cable specified by the ODVA is required for connecting the participants to DeviceNet. Only cables that satisfy the ODVA specifications may be used.

The limits of network expansion without repeater are specified by the ODVA. The specified limit values are dependent on the design of the data line.

A distinction is made between "thick cable", "mid cable" and "thin cable".

**DeviceNet installation**

Up to 64 network devices can communicate with one another in a DeviceNet network with baud rates of 125, 250 or 500 kBaud. In addition to the two signals for data transmission—CAN-L and CAN-H—the DeviceNet cable also includes two cables for supplying the DeviceNet network device with 11 ... 25VDC-volt. The connection of the MA separates the operating voltage and the field bus voltage, the transmission electronics, however, require V+ and V- via the CAN cable.

The maximum length of the DeviceNet cable is dependent on the selected cable type and baud rate.

Listed in the table are the max. network expansions as a function of the used data line without repeater.

	Transmission rate								
	125 kbit/s			250 kbit/s			500 kbit/s		
	1 <sup>1)</sup>	2 <sup>2)</sup>	3 <sup>3)</sup>	1	2	3	1	2	3
Max. length of master line (trunk line) in m	500	300	100	250		100	100		
Max. length of stub cable (drop line) in m	6			6			6		
Max. length of all sub cables per network in m	156			78			39		

- 1) Thick cable = 1
- 2) Mid cable = 2
- 3) Thin cable = 3

The ready-made data lines from Leuze electronic correspond to the thin cable.

**Communication**

The gateway MA 255*i* supports the CIP-based DeviceNet protocol and requires the EDS file (**E**lectronic **D**ata **S**heet) for communication; it is provided in the Download area of the Leuze home page.

You can find the EDS file at:

**[www.leuze.com](http://www.leuze.com) -> Download -> identify -> Modular interfacing units.**

The EDS file is named "MA255i.eds"; the corresponding icon is named "MA255i.ico".

The EDS file includes all communication parameters of the participants as well as the available objects. The DeviceNet communication tool reads the EDS files of the participants present in the network and uses this information to calculate the configuration data that is subsequently loaded onto the participants.

The input/output data is addressed according to the following fundamental scheme:

1. Device address (MAC ID)  
The participant is addressed with its MAC ID, which is unique in the network.
2. Object class identifier (class)  
Used as the basis for addressing the desired object class.
3. Object instance identifier (instance)  
Addressing of the object instance within the object class.
4. Attribute identifier (attribute)  
Addressing of the attribute within the object instance.
5. Service code (get, set, reset, start, stop and others...)  
The maintenance code ultimately describes the type of access to the data, e.g., reading or writing.

## 5 Specifications

### 5.1 General specifications

#### Electrical data

Interface type 1		DeviceNet, integrated switch
		BUS: 1x M12 connector (A-coded), 1x M12 socket (A-coded)
		PWR/IO: 1x M12 connector (A-coded), 1x M12 socket (A-coded)
	Baud rate	125 (default) / 250 / 500 kBd
	Vendor ID	524Dec / 20CH
	Device type	12Dez / 0CH (communications adapter)
	Position sensor type	Product Type 1004 (gateway)
Interface type 2		RS 232
	Baud rate	300bit/s ... 115200bit/s, default: 9600
Service interface		RS 232, 9-pin Sub-D connector, Leuze standard
	Data format	data bit: 8, parity: None, stop bit: 1
Switching input/output		1 switching input/1 switching output device-dependent voltage
Operating voltage		18 ... 30VDC
Power consumption		max. 5VA (without DEV, current consumption max. 300mA)
Max stress on the connector (PWR IN/OUT)		3A

#### Indicators

MNS LED	green	Bus state ok
	red	Bus error
PWR LED	green	Power
	red	Collection error

#### Mechanical data

Protection class		IP 65 (with screwed-on M12 and connected Leuze device)
Weight		700 g
Dimensions (WxHxD)		130 x 90 x 41 mm / with plate: 180 x 108 x 41 mm
Housing		diecast aluminum
Connection		2 x M12: BUS IN / BUS OUT DeviceNet 1 connector: RS 232 1 x M12: Power IN/GND and switching input/output 1 x M12: Power OUT/GND and switching input/output

#### Environmental data

Operating temperature range		0°C ... +55°C
Storage temperature range		-20°C ... +60°C
Air humidity		max. 90% rel. humidity, non-condensing

Vibration	IEC 60068-2-6, test FC
Shock	IEC 60068-2-27, test Ea
Electromagnetic compatibility	EN 61000-6-3:2007 (interference emissions for residential, commercial and light-industrial environments) EN 61000-6-2:2005 (interference rejection for industrial sectors)

## 5.2 Dimensioned drawings

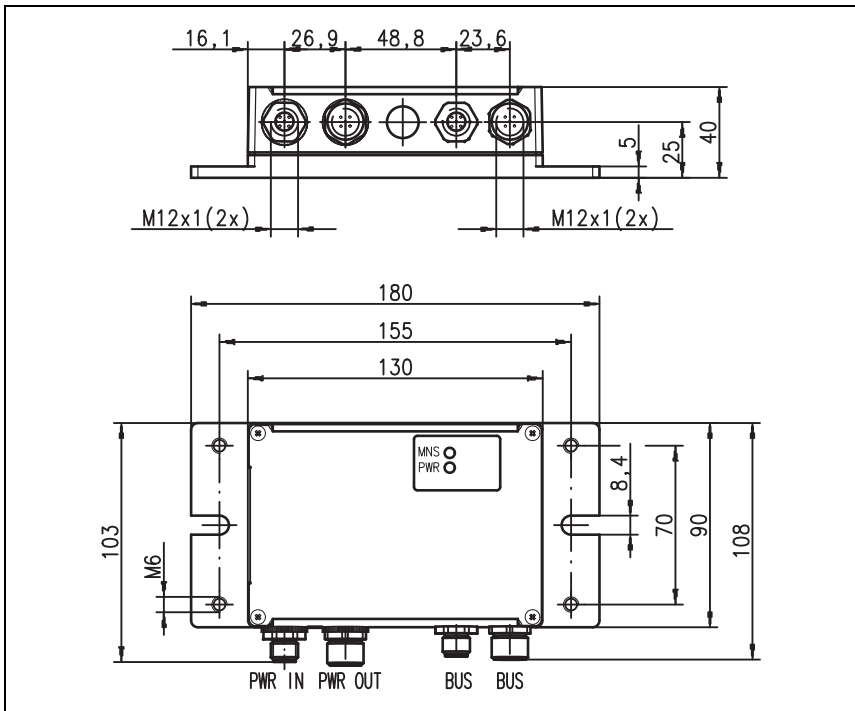

Figure 5.1: Dimensioned drawing MA 255*i*



### 5.3 Type overview

The following versions of the MA 2xx*i* gateway family are available for facilitating the integration of Leuze RS 232 devices in the various fieldbus types.

Fieldbus	Device type	Part no.
PROFIBUS DP V0	MA 204 <i>i</i>	50112893
EtherNet TCP/IP	MA 208 <i>i</i>	50112892
PROFINET-IO RT	MA 248 <i>i</i>	50112891
DeviceNet	MA 255 <i>i</i>	50114156
CANopen	MA 235 <i>i</i>	50114154
EtherCAT	MA 238 <i>i</i>	50114155
EtherNet/IP	MA 258 <i>i</i>	50114157

Table 5.1: Type overview MA 2xx*i*

## 6 Installation and mounting

### 6.1 Storage, transportation

**Attention!**

When transporting or storing, package the device so that it is protected against collision and humidity. Optimum protection is achieved when using the original packaging. Heed the required environmental conditions specified in the technical data.

**Unpacking**

- ↳ Check the packaging for any damage. If damage is found, notify the post office or shipping agent as well as the supplier.
- ↳ Check the delivery contents using your order and the delivery papers:
  - Delivered quantity
  - Device type and model as indicated on the nameplate
  - Brief manual

The name plate provides information as to what MA 2xx*i* type your device is. For specific information, please refer to the package insert or chapter 14.2.

**Name plate of the connector unit**

Figure 6.1: Device name plate MA 255*i*

- ↳ Save the original packaging for later storage or shipping.

If you have any questions concerning your shipment, please contact your supplier or your local Leuze electronic sales office.

- ↳ Observe the applicable local regulations when disposing of the packaging materials.

## 6.2 Mounting

The gateway mounting plate MA 255*i* can be mounted in two different ways:

- using four threaded holes (M6) or
- Using two M8 screws on the two lateral grooves.

### *Fastening by means of four M6 or two M8 screws*



Figure 6.2: Fastening options

## 6.3 Device arrangement

Ideally, the MA 255*i* should be mounted so that it is easily accessible near the ident device in order to ensure good operability, e.g., for configuring the connected device.

### 6.3.1 Selecting a mounting location

In order to select the right mounting location, several factors must be considered:

- The permissible cable lengths between the MA 255*i* and the host system depending on which interface is used.
- The housing cover should be easily accessible, so that the internal interfaces (device interface for connecting the Leuze device via PCB connectors, service interface) and other operational controls are easy to reach.
- Maintaining the required environmental conditions (temperature, humidity).
- Lowest possible chance of damage to the MA 255*i* by mechanical collision or jammed parts.

## 6.4 Cleaning

 Clean the housing of the MA 255*i* with a soft cloth after mounting. Remove all packaging remains, e.g., carton fibers or Styrofoam balls.



### **Attention!**

Do not use aggressive cleaning agents such as thinner or acetone for cleaning the device.

## 7 Electrical connection

The fieldbus gateways MA 2xx*i* are connected using coded M12 connectors.

An RS 232 device interface allows the respective devices to be connected with system connectors. The device cables are equipped with a prefabricated PG cable gland.

Coding varies and the design is implemented as either socket or connector depending on the HOST (fieldbus) interface and function. For the exact design, refer to the corresponding description of the MA 2xx*i* device type.



### Notice!

The corresponding mating connectors and ready-made cables are available as accessories for all cables. For further information, see chapter 14 "Type overview and accessories".



Figure 7.1: Location of the electrical connections

### 7.1 Safety notices for the electrical connection



#### Attention!

Before connecting the device, be sure that the supply voltage agrees with the value printed on the name plate.

Connection of the device and cleaning must only be carried out by a qualified electrician.

Ensure that the functional earth (FE) is connected correctly. Unimpaired operation is only guaranteed when the functional earth is connected properly.

If faults cannot be corrected, the device should be removed from operation and protected against possible use.



#### Attention!

For UL applications, use is permitted exclusively in Class 2 circuits according to NEC (National Electric Code).



The fieldbus gateways are designed in accordance with safety class III for supply by PELV (protective extra-low voltage with reliable disconnection).



### Notice!

Protection class IP65 is achieved only if the connectors and caps are screwed into place!

## 7.2 Electrical connection

The MA 255*i* features four M12 connectors/sockets; each is A-coded.

The voltage supply (**PWR IN**) as well as the switching inputs/outputs (**PWR OUT** or **PWR IN**) are connected there. The number and function of the switching inputs/outputs is dependent on the connected end device.

An internal RS 232 interface is used for connecting the respective Leuze device. Another internal RS 232 interface functions as a service interface for configuring the connected device via a serial null modem cable.

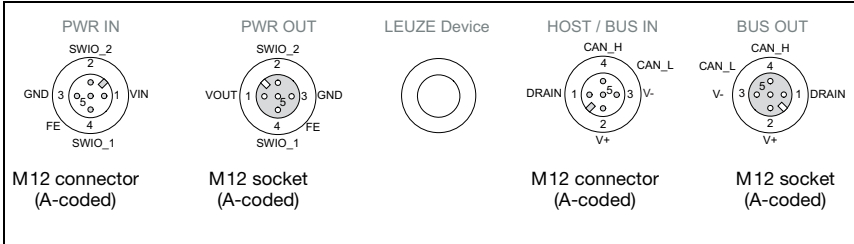

Figure 7.2: Connections of the MA 255*i*, view: laying on mounting plate

Described in detail in the following are the individual connections and pin assignments.



### Attention!

Voltage supply and bus cable are coded in the same way. Please observe the printed connection designations

### 7.2.1 PWR IN – voltage supply / switching input/output

PWR IN (5-pin connector, A-coded)			
	Pin	Name	Remark
 <p>PWR IN SWIO_2 2 1 VIN 3 GND 4 SWIO_1 5 FE M12 connector (A-coded)</p>	1	VIN	Positive supply voltage +18 ... +30VDC
	2	SWIO_2	Switching input/switching output 2
	3	GND	Negative supply voltage 0VDC
	4	SWIO_1	Switching input/switching output 1
	5	FE	Functional earth
	Thread	FE	Functional earth (housing)

Table 7.1: Pin assignment PWR IN



**Notice!**

The designation and function of the SWIO depends on the connected device. Please observe the following table!

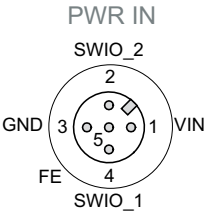
Device	PIN 2	PIN 4
BCL 22/BCL 32	SWOUT_1	SWIN_1
BCL 8	SW_0	SW_I
Hand-held scanner/BCL 90	n.c.	n.c.
RFM/RFU/RFI	SWOUT_1	SWIN_1
LSIS 122	SWOUT	SWIN
LSIS 4x2/BCL 500	Configurable IO 1 / SWIO 3 IO 2 / SWIO 4	Configurable
KONTURflex	n.c.	n.c.
ODSL 9, ODSL 96B	Q1	n.c.
ODSL 30	Q1	Active/reference (on SWIN_1, PWRIN)

Table 7.1: Device-specific function of the SWIOs

**Supply voltage**



**Attention!**

For UL applications, use is permitted exclusively in Class 2 circuits according to NEC (National Electric Code).



The fieldbus gateways are designed in accordance with safety class III for supply by PELV (protective extra-low voltage with reliable disconnection).

**Connecting functional earth FE**



**Notice!**

Ensure that the functional earth (FE) is connected correctly. Unimpaired operation is only guaranteed when the functional earth is connected properly. All electrical disturbances (EMC couplings) are discharged via the functional earth connection.

**Switching input/output**

The MA 255*i* is equipped with the **SWIO\_1** and **SWIO\_2** switching input/output. This is located on the PWR IN M12 connector and on the PWR OUT M12 connector. The connection of the switching inputs/outputs from PWR IN to PWR OUT can be interrupted by means of a jumper. In this case, only the switching input and output on PWR IN are active.

The function of the switching inputs and outputs is dependent on the connected Leuze device. Detailed information on this topic can be found in the respective operating instructions.

### 7.2.2 PWR OUT switching input/output

PWR OUT (5-pin socket, A-coded)			
	Pin	Name	Remark
	1	VOUT	Voltage supply for additional devices (VOUT identical to VIN at PWR IN)
	2	SWIO_2	Switching input/switching output 2
	3	GND	GND
	4	SWIO_1	Switching input/switching output 1
	5	FE	Functional earth
	Thread	FE	Functional earth (housing)

Table 7.2: Pin assignment PWR OUT



**Notice!**

The maximum admissible current of the PWR OUT and IN connectors is maximum 3A. To be subtracted from this is the current consumption of both the MA and of the connected end device.

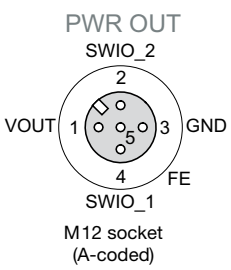
The function of the switching inputs and outputs is dependent on the connected Leuze device. Detailed information on this topic can be found in the respective operating instructions.

On delivery, the SWIO 1/2 are connected in parallel on PWR IN/OUT. This connection can be separated with a jumper.

### 7.3 BUS IN

The MA 255*i* provides a DeviceNet interface as a HOST interface.



BUS IN (5-pin plug, A-coded)			
	Pin	Name	Remark
	1	Drain	Shield
	2	V+	Supply voltage data V+
	3	V-	Supply voltage data V-
	4	CAN_H	Data signal CAN_H
	5	CAN_L	Data signal CAN_L
	Thread	FE	Functional earth (housing)

Table 7.3: Pin assignments for DeviceNet BUS IN

 For the host connection of the MA 255*i*, the ready-made KB DN/CAN-xxxx-Bx cables are preferred, table 14.5 "Bus connection cable for the MA 255*i*" on page 80.

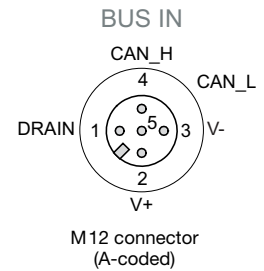

## 7.4 BUS OUT

BUS OUT (5-pin socket, A-coded)			
 <p>BUS OUT</p> <p>CAN_H</p> <p>CAN_L</p> <p>V- 3 1 DRAIN</p> <p>2</p> <p>V+</p> <p>M12 socket (A-coded)</p>	Pin	Name	Remark
	1	Drain	Shield
	2	V+	Supply voltage data V+
	3	V-	Supply voltage data V-
	4	CAN_H	Data signal CAN_H
	5	CAN_L	Data signal CAN_L
	Thread	FE	Functional earth (housing)

Table 7.4: Pin assignments for DeviceNet BUS OUT

↪ For the host connection of the MA 255*i*, the ready-made KB DN/CAN-xxxx-Sx cables are preferred, table 14.5 "Bus connection cable for the MA 255*i*" on page 80.

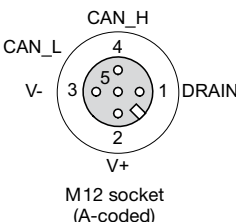

**Notice!**

Ensure adequate shielding. For the devices and ready-made cables offered by Leuze electronic, the shield is on PIN 1.

### 7.4.1 Termination of the DeviceNet

The last physical DeviceNet participant must be terminated with a terminating resistor (see "Accessory terminating resistor" on page 77).



**Attention!**

After DeviceNet specification (Volume 3: DeviceNet Adaptation of CIP Chapter 8, Physical Layer 8-3.3 Connectors), use of the BUS OUT connection is not allowed.

## 7.5 Device interfaces

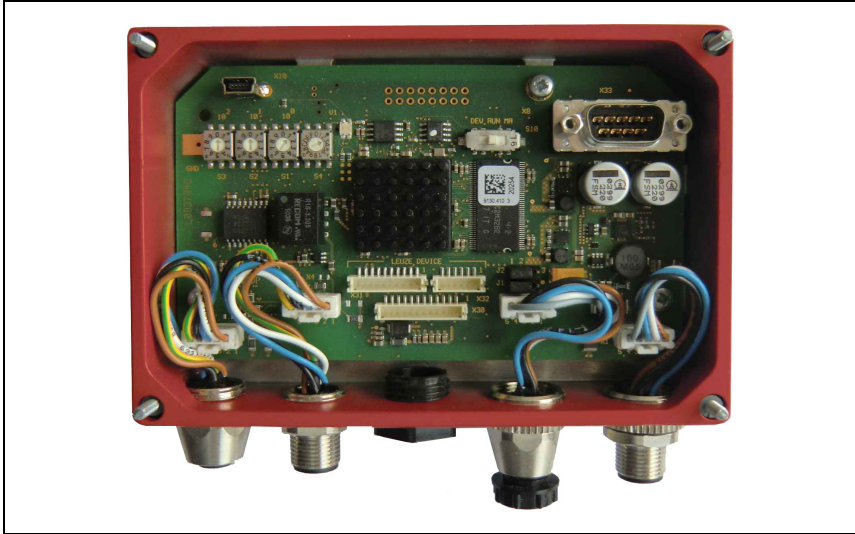

Figure 7.3: Open MA 255*i*

### 7.5.1 RS 232 device interface (accessible after opening the device, internal)

The device interface is prepared for the system plugs (PCB connectors) for Leuze devices RFI xx, RFM xx, BCL 22 as well as BCL 32, VR with KB 031.

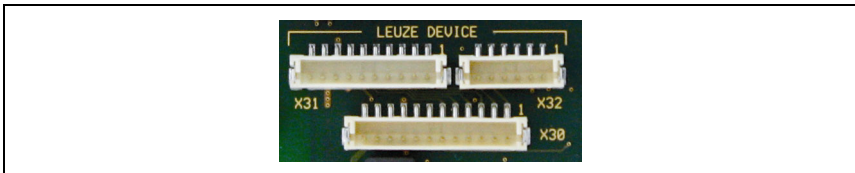

Figure 7.4: RS 232 device interface

The standard devices are connected with 6- or 10-pin connector piece to X31 or X32, respectively. For hand-held scanners, BCL 8 and BPS 8 with 5VDC supply (from the MA) on pin 9, the 12-pin X30 PCB connection is available as well.

By using an additional cable (cf. "Type overview and accessories" on page 77), the system connection can be established on M12 or 9-pin Sub-D, e.g., for hand-held scanners.

7.5.2 Service interface (internal)

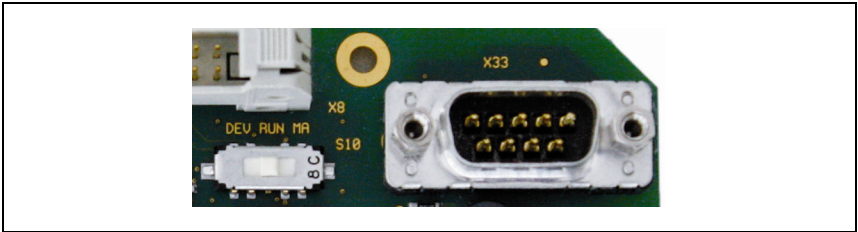

Figure 7.5: RS 232 service switch and service interface

Following activation, this interface enables access via the RS 232 to the connected Leuze device and the MA for configuration using the 9-pin Sub-D. The connection between the fieldbus interface and the device interface is switched off during access. The fieldbus itself is, however, not interrupted as a result.

The service interface can be accessed once the MA 255*i* housing cover has been removed and features a 9-pin Sub-D connector (male). A crossed RS 232 connection cable is required to make the RxD, TxD and GND connections. A hardware handshake via RTS, CTS is not supported at the service interface.

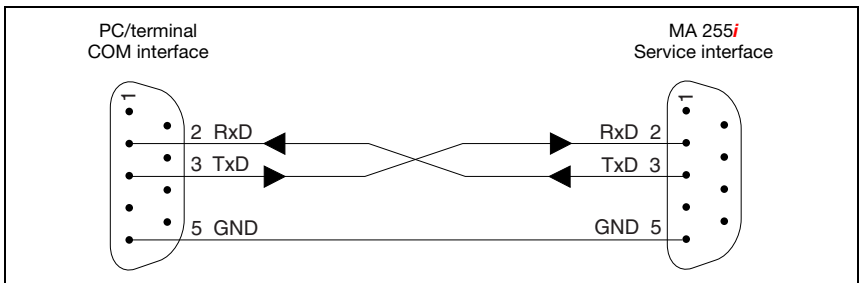

Figure 7.6: Connecting the service interface to a PC/terminal



**Attention!**

For the service PC to function, the RS 232 parameters must be the same as those of the MA. The Leuze standard setting of the interface is 9600Bd, 8N1 and STX, data, CR, LF.



**Notice!**

To configure the devices connected to the external interface, e.g., BCL 8 (JST plug connector "X30"), a cable specially configured for this purpose is necessary. The service switch must be in the "DEV" or "MA" position (Service Leuze device/MA).

## 8 Status displays and operational controls







Figure 8.1: LED indicators on the MA 255*i*

### 8.1 LED status indicators





#### 8.1.1 LED indicators on the circuit board

##### *LED (Status)*





	<b>off</b>	<b>Device OFF</b> - no operating voltage or device defect
	<b>continuous green light</b>	<b>Device ok</b> - readiness for operation
	<b>continuous orange light</b>	<b>Device error/ firmware available</b>
	<b>flashing green-orange</b>	<b>Device in boot mode</b> - no firmware

8.1.2 LED indicators on the housing

**MNS LED**

MNS 	<b>continuous green light</b>	<b>Bus operation ok</b> - network mode ok - connection and communication to the host established
MNS 	<b>flashing green</b>	<b>Device ok</b> - no connection to HOST - no termination
MNS 	<b>red continuous light</b>	<b>Network error</b> - interference on DeviceNet - no connection established - no communication possible
MNS 	<b>flashing red</b>	<b>Time exceeded during establishment of connection</b>
MNS 	<b>flashing red/green/off</b>	<b>Self-test after switching on</b>

**PWR LED**

PWR 	<b>off</b>	<b>Device OFF</b> - no operating voltage or device error
PWR 	<b>continuous green light</b>	<b>Device ok</b> - self test successfully finished - ready
PWR 	<b>flashing green</b>	<b>Device ok, device in service mode</b>
PWR 	<b>red, flashing</b>	<b>Configuration error</b> - baud rate or address incorrect

## 8.2 Internal interfaces and operational controls

### 8.2.1 Overview of operational controls of the

The operational controls of the MA 255*i* are described in the following. The figure shows the MA 255*i* with opened housing cover.

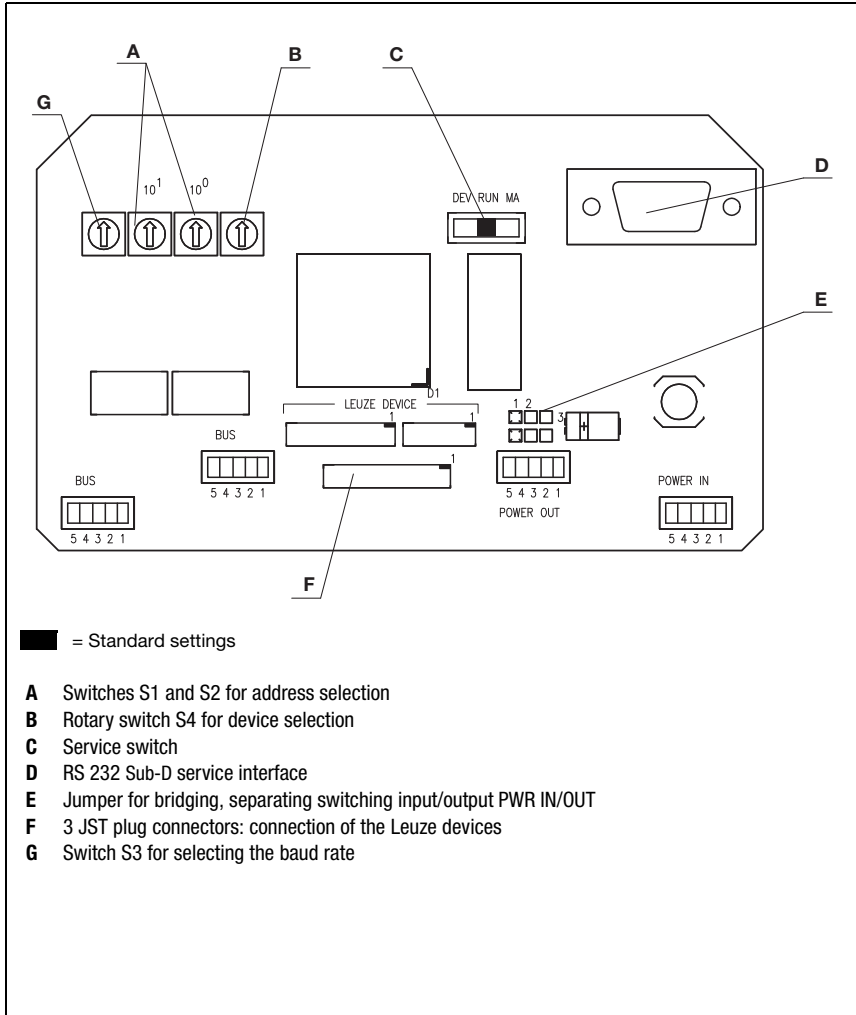

Figure 8.2: Front view: operational controls of the MA 255*i*

<b>Circuit board element designation</b>	<b>Function</b>
X1 Operating voltage	PWR IN M12 connector for operating voltage (18 ... 30VDC) MA 255 <i>i</i> and connected Leuze device xx
X2 Output voltage	PWR OUT M12 connector for other devices (MA, BCL, sensor, ...) VOUT = VIN max. 3A
X4 HOST interface	BUS IN HOST interface for connecting to the fieldbus
X5 HOST interface	BUS OUT Second BUS interface for creating a network with other participants in a linear topology
X30 Leuze device	JST plug connector with 12 pins Connection of the Leuze devices with 5V / 1A (BCL 8, BPS 8 and hand-held scanner)
X31 Leuze device	JST plug connector with 10 pins Connection of the Leuze devices (BCL, RFI, RFM, ...) Pin VINBCL with default setting = V+ (18 - 30V)
X32 Leuze device	JST plug connector with 6 pins Connection of the Leuze devices (BCL, RFI, RFM, ...) Pin VINBCL with default setting = V+ (18 - 30V)
X33 RS 232 service interface	9-pin SUB-D connector RS 232 interface for service/setup operation. Enables the connection of a PC via serial null modem cable for configuring the Leuze device and the MA 255 <i>i</i> .
S4 Rotary switch	Rotary switch (0 ... F) for device selection Default setting = 0
S10 DIP switch	Service switch Switch between service Leuze device (DEV), service fieldbus gateway (MA) and operation (RUN). Standard setting = operation.
J1, J2 Jumper	Bridging, separating switching input/output (interruption of connection between the two PWR M12 connectors of the SWIO 1/SWIO 2)
S1 Rotary switch	Rotary switch (0 ... 9) for address selection 10 <sup>^</sup> 0 Default setting: position 0
S2 Rotary switch	Rotary switch (0 ... 9) for address selection 10 <sup>^</sup> 1 Default setting: position 0
S3 Rotary switch	Baud rate selector switch pos 1-3 (125/250/500kBd) Default setting = Pos 1

### 8.2.2 Connector X30 ... connectors

PCB connectors **X30 ... X32** are available in the MA 255*i* for connecting the respective Leuze devices via RS 232.

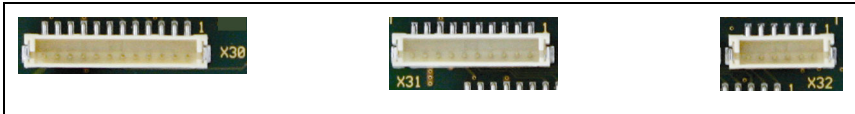

Figure 8.3: Connections for Leuze devices



**Attention!**

Several Leuze devices may not be connected to the MA 255*i* simultaneously, as only one RS 232 interface can be operated.

### 8.2.3 RS 232 service interface – X33

The **X33** RS 232 interface facilitates the configuration of the Leuze device and the MA 255*i* via PC, which is connected by means of a serial null modem cable.

**X33 pin assignment – service connector**

SERVICE (9-pin SUB-D connector)			
	Pin	Name	Remark
	2	RXD	Receive Data
	3	TXD	Transmit Data
	5	GND	Functional earth

Table 8.1: SERVICE pin assignment

### 8.2.4 S10 service switch

The **S10** DIP switch can be used to select between the "operation" and "service" modes, i.e. you switch between the following options here:

- Operation (RUN) = default setting
- Service Leuze device (DEV) and
- Service fieldbus gateway (MA)

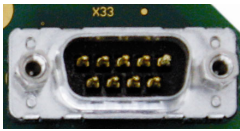
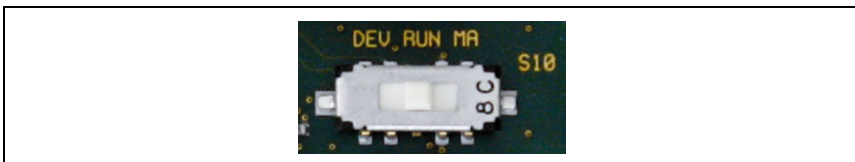

Figure 8.4: DIP switch service - operation



For further information on the corresponding options, see chapter 4.4 "Operating modes".

**8.2.5 Rotary switch S4 for device selection**

The **S4** rotary switch is used to select the Leuze end device.



Figure 8.5: Rotary switch for device selection

The following switch positions are assigned to the Leuze devices:

Leuze device	Switch position
Standard setting Other RS 232 devices such as KONTURflex QUATTRO	0
BCL 8	1
BCL 22	2
BCL 32	3
BCL 300i, BCL 500i	4
BCL 90	5
LSIS 122	6

Leuze device	Switch position
LSIS 4x2i	7
Hand scanner	8
RFID (RFI xx, RFM xx, RFU xx)	9
BPS 8	A
AMS, ODS 9, ODSL 30, ODSL 96B	B
MA 3x	C
Reset to factory setting	F

The gateway is set via the switch position on the Leuze device. If the switch position is changed, the device must be restarted, since the switch position is only queried after switching off completely and then restarting the device.



**Note!**

*In switch position "0", a distance of >20ms must be maintained between two telegrams so they can be distinguished from one another.*

The parameters of the Leuze end devices are described in chapter 16.

### 8.2.6 Switch for address selection in the fieldbus

The gateway features the **S1** and **S2** rotary switches (ones and tens digits) for setting the station address.

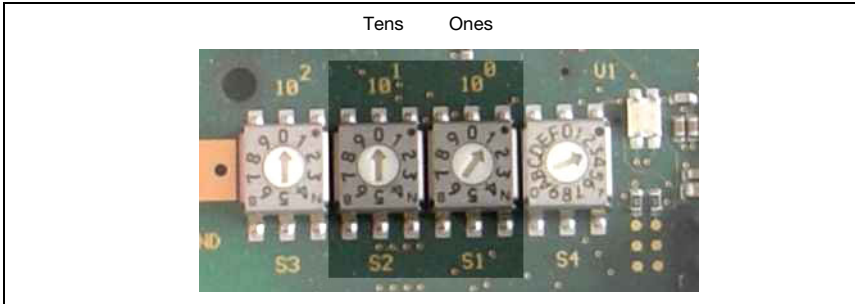

Figure 8.6: Rotary switch for setting the address

Further information on the respective address ranges and the addressing procedure can be found in chapter 12.1.

### 8.2.7 Switch for setting the baud rate

You can set the baud rate for data transmission with the **S3** rotary switch.

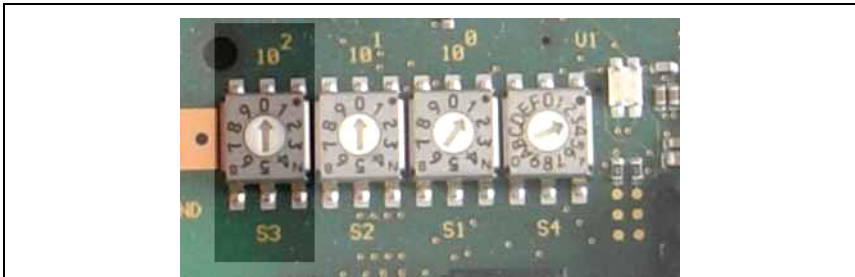

Figure 8.7: Rotary switch for setting baud rate

## 9 Configuration

The MA 255*i* is configured using the EDS file via the device manager of the control. The connected device is normally configured via the service interface of the MA with the help of a suitable configuration program.

The respective configuration programs – e.g. for bar code readers the BCL-Config, for RFID devices the RF-Config etc. – and the associated documentation is provided on the Leuze home page in the Download area:

**[www.leuze.de \ download \ identify](http://www.leuze.de/download/identify)**



### **Notice!**

*In order to display the help texts, a PDF viewer program (not included in the delivery contents) must also be installed. For important information on configuring and on the configurable functions, please refer to the description of the respective device.*

### 9.1 Connecting the service interface

The RS 232 service interface is connected after opening the device cover of the MA 255*i* via the 9-pin Sub-D and a cross-wired null modem cable (RxD/TXD/GND). For connection, see chapter "Service interface (internal)" on page 33.

The service interface is activated with the help of the service switch and establishes a direct connection to the connected device with the "DEV" (Leuze device) or "MA" (gateway) setting.

### 9.2 Reading out information in service mode

- ↳ *After starting up in the "RUN" switch position, set the service switch of the MA to the "MA" position.*
- ↳ *Now start one of the following terminal programs: e.g., BCL, RF, BPS Config.*  
Alternatively, you can also use the Windows tool "Hyperterminal".
- ↳ *Start the program.*
- ↳ *Select the correct COM port (e.g., COM1) and set the interface as follows:*

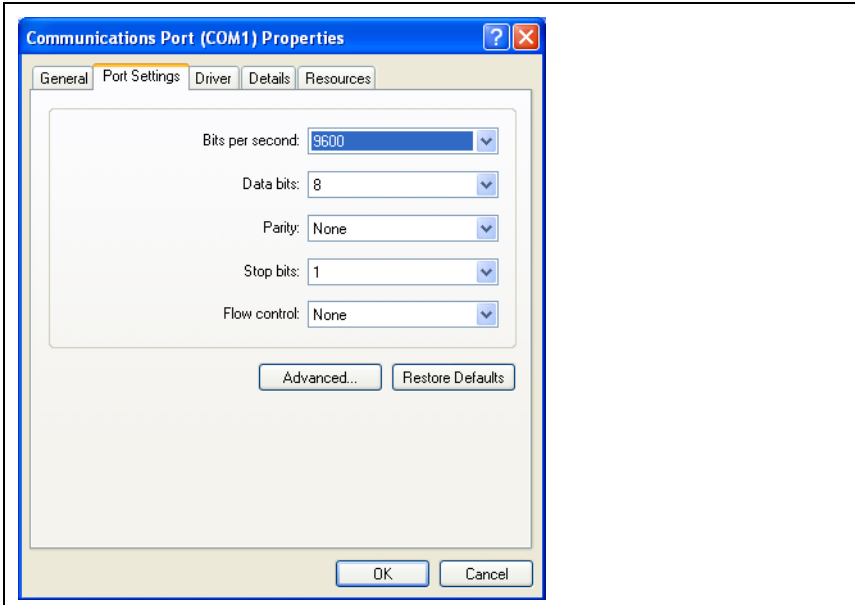

Figure 9.1: COM port settings



**Notice!**

Observe that *STX*, *data*, *CR*, *LF* framing must be set on the PC terminal program so that communication is possible with the connected Leuze device.

**Commands**

You can now call up information on the MA 255*i* by sending the following commands.

v	General service information.
s	Enable memory mode for the last frames.
l	The memory mode shows the last RX and TX frames for ASCII and fieldbus.

Table 9.1: Available commands

**Information**

Version	Version information.
Firmware date	Firmware date.

Table 9.2: General firmware information

Selected scanner	Currently selected Leuze device (selected via switch S4).
Gateway mode	Transparent or Collective mode.
Ring buffer fill level	Current fill level of the ring memory in Collective mode (ASCII->Fieldbus). 1024 bytes max.
Received ASCII Frames	Number of received ASCII frames.
ASCII Framing Error (GW)	Number of received framing errors.
Number of Received CTB's	Number of CTB commands.
Number of Received SFB's	Number of SFB commands.
Command-Buffer fill level	Current fill level of the ring memory in Command mode (fieldbus->ASCII). 1024 bytes max.
Number of received transparent frames	Number of received fieldbus frames without CTB/SFB.
Number of send fieldbus frames	Number of frames sent via the fieldbus.
Number of invalid commands	Number of invalid commands.
Number of ASCII stack send errors	Number of frames that the ASCII memory could not send.
Number of good ASCII send frames	Number of frames that the ASCII memory sent successfully.

Table 9.3: General gateway information

ND	Current status of ND bit.
W-Ack	Current status of W-Ack bit.
R-Ack	Current status R-Ack bit.
Data loss	Current status of data loss bit.
Ring buffer overflow	Current status of ring buffer overflow bit.
DEX	Current status of DEX bit.
BLR	Current status of BLR bit.

Table 9.4: Current states of the status and control bits

ASCII start byte	Currently configured start byte (dependent on switch position S4).
ASCII end byte1	Currently configured stop byte 1 (dependent on switch position S4).
ASCII end byte2	Currently configured stop byte 2 (dependent on switch position S4).
ASCII data frame	Currently configured data frame.
ASCII warm start status	Indicates whether the ASCII memory has detected and accepted a valid configuration.
ASCII baud rate	Currently configured baud rate (dependent on switch position S4).

Table 9.5: ASCII configuration

DNS Input Data length	Length of the data received (consumed data, default 4 bytes).
DNS Output Data length	Length of the data supplied (produced data, default 18 bytes).
DNS Node ID	Participant address of the address switch.
DNS Baud Rate[kBaud]	Set baud rate.

Table 9.6: DeviceNet parameter MA 255*i*

## 10 Telegram

### 10.1 Structure of the fieldbus telegram

All operations are performed by control and status bits. Two bytes of control information and two bytes of status information are available for this purpose. The control bits are a part of the output module and the status bits are a part of the input bytes. The data starts with the third byte.

If the actual data length is longer than the data length configured in the gateway, only part of the data is transmitted; the remaining data is lost. In this case, the DL (data loss) bit is set.

The following telegram structure is used between **PLC -> fieldbus gateway**:

7	6	5	4	3	2	1	0	
ND	Address 4	Address 3	Address 2	Address 1	Address 0	Broadcast	Command mode	Control byte 0
				CTB	SFB		R-ACK	Control byte 1
Data byte / parameter byte 0								Data
Data byte / parameter byte 1								
...								

This telegram structure is used between **fieldbus gateway -> PLC**:

7	6	5	4	3	2	1	0	
ND	B0	DL	BLR	DEX	SMA		W-ACK	Status byte 0
DLC7	DLC6	DLC5	DLC4	DLC3	DLC2	DLC1	DLC0	Status byte 1
Data byte / parameter byte 0								Data
Data byte / parameter byte 1								
...								

Only the data part with the corresponding frame (e.g., STX, CR & LF) is then transmitted between the fieldbus gateway and the Leuze end device. The two control bytes are processed by the fieldbus gateway.

The corresponding control and status bits and their meaning are specified in section 10.2 and section 10.3.

Further information on the broadcast control bytes and address bits 0 ... 4 can be found in chapter "Modular interfacing unit MA 3x (S4 switch position C)" on page 97.

## 10.2 Description of the input bytes (status bytes)

### 10.2.1 Structure and meaning of the input bytes (status bytes)

7	6	5	4	3	2	1	0	
ND	BO	DL	BLR	DEX	SMA		W-ACK	Status byte 0
DLC7	DLC6	DLC5	DLC4	DLC3	DLC2	DLC1	DLC0	Status byte 1
Data byte / parameter byte 0								Data
Data byte / parameter byte 1								
...								

Table 10.1: Structure of the input bytes (status bytes)

#### **Bits of the input byte (status byte) 0**

Bit no.	Designation	Meaning
0	W-ACK	Write-Acknowledge (write confirmation when using buffer)
2	SMA	Service mode active(service mode activated)
3	DEX	Data exist (data in transmit buffer)
4	BLR	Next block ready (new block ready)
5	DL	Data loss
6	BO	Buffer overflow
7	ND	New data only in Transparent mode

#### **Bits of the input byte (status byte) 1**

Bit no.	Designation	Meaning
0 ... 7	DLC0 ... DLC7	Data Length Code (length of the following user data)



**Notice!**

*T-bit means toggle bit, i.e. this bit changes its state on each event ("0" → "1" or "1" → "0").*

## 10.2.2 Detailed description of the bits (input byte 0)

### **Bit 0: Write-Acknowledge: W-ACK**

This bit is only relevant for writing slave data in blocks, see chapter 11.1.2 (buffer data on RS 232). It toggles when data from the PLC are sent to the MA with CTB or SFB.

Input data	Description	Addr.	Data type	Value range	Default
W-ACK	<p><b>Write-Acknowledge</b> (write confirmation) Write handshake Indicates that the data was successfully sent by the PLC to the gateway. Write-Acknowledge is indicated via this bit. The W-ACK bit is toggled by the fieldbus gateway whenever a transmit command has been successfully executed. This applies both for the transmission of data to the transmit buffer with the CTB command and for sending the transmit buffer contents with the SFB command.</p>	0.0	Bit	<p>0-&gt;1: Successfully written 1-&gt;0: Successfully written</p>	0

### **Bit 2: Service mode active: SMA**

Input data	Description	Addr.	Data type	Value range	Default
SMA	<p><b>Service mode active (SMA)</b> The SMA bit is set if the service switch is set to "MA" or "DEV", i.e. if the device is in either fieldbus gateway or Leuze device service mode. This is also indicated by a flashing PWR LED on the front side of the device. Upon changing to the normal operating mode "RUN", the bit is reset.</p>	0.2	Bit	<p>0: Device in operating mode 1: Device in service mode</p>	0h

### **Bit 3: Data exist: DEX**

This bit is only relevant for reading slave data in Collective mode relevant, see chapter 11.1.1.

Input data	Description	Addr.	Data type	Value range	Default
DEX	<p><b>Data exist</b> (data in transmit buffer) Indicates that further data is stored in the transmit buffer which is ready for transmission to the control. This flag bit is always set to high ("1") by the fieldbus gateway as long as data is in the buffer.</p>	0.3	Bit	<p>0: No data in the transmit buffer 1: Further data in the transmit buffer</p>	0h



**Bit 4: Next block ready to transmit: BLR**

This bit is only relevant for reading slave data in Collective mode relevant, see chapter 11.1.1.

Input data	Description	Addr.	Data type	Value range	Default
BLR	Next block ready to transmit (new block ready) The Block Ready toggle bit changes its state whenever the fieldbus gateway has removed received data from the receive buffer and registered it in the corresponding receive-data bytes. This signals to the master that the quantity of data indicated in the DLC bits to be present in the input data bytes originated in the data buffer and is current.	0.4	Bit	0->1: Data transmitted 1->0: Data transmitted	0

**Bit 5: Data loss: DL**

This bit is important for monitoring data transmission in Transparent and Collective mode.

Input data	Description	Addr.	Data type	Value range	Default
DL	Data loss (Data transmission monitoring) This bit is set until the device is reset (bit pattern see chapter 10.4 "RESET function / deleting memory") in case gateway data was not able to be sent to the PLC and was lost. Furthermore, this bit is set in case the configured data frame, e.g. 8 bit, should be smaller than the data to be transmitted to the PLC, e.g. bar code with 20 digits. In this case, the first 8 digits are transmitted to the PLC, the rest are truncated and are lost. In this process, the Data loss bit is also set.	0.6	Bit	0->1: Data loss	0

**Bit 6: Buffer overflow: BO**

Input data	Description	Addr.	Data type	Value range	Default
BO	Buffer overflow (buffer overflow) This flag bit is set to high ("1") when the buffer overflows. The bit is automatically reset when the buffer again has memory space available. While the BO bit is set, the RTS signal of the serial interface is deactivated. The memory size of the gateway for the data of both the PLC and the Leuze end device is 1 kByte.	0.6	Bit	0->1: Buffer overflow 1->0: Buffer o.k.	0

**Bit 7: New data: ND**

This bit is only relevant in Transparent mode.

Input data	Description	Addr.	Data type	Value range	Default
ND	New data (new data) This bit is toggled on each data set that is sent from the gateway to the PLC. This can be used to differentiate between multiple, identical data sets that are sent to the PLC.	0.7	Bit	0->1; 1->0: On each status change for new data	0

**10.2.3 Detailed description of the bits (input byte 1)**

**Bit 0 ... 7: Data length code: DLC0 ... DLC7**

Input data	Description	Addr.	Data type	Value range	Default
DLC0 ... DLC7	Data length code (number of user data in bytes) Stored in these bits is the number of user data bytes transmitted to the PLC which follow.	1.0 ... 1.7	Bit	1 <sub>h</sub> (00001 <sub>b</sub> ) ... FF <sub>h</sub> (00255 <sub>d</sub> )	0h (00000b)

**10.3 Description of the output bytes (control bytes)**

**10.3.1 Structure and meaning of the output bytes (control bytes)**

7	6	5	4	3	2	1	0	
ND	Address 4	Address 3	Address 2	Address 1	Address 0	Broadcast	Command mode	Control byte 0
				CTB	SFB		R-ACK	Control byte 1
Data byte 1								Data
Data byte 2								
...								

Table 10.2: Structure of the output bytes (control bytes)

**Bits of the output byte (control byte) 0**

Bit no.	Designation	Meaning
0	Command mode	Command mode
1	Broadcast	Broadcast (only relevant with a connected MA 3x)
2 ... 6	Address 0 .. 4	Address bits 0 .. 4 (only relevant with a connected MA 3x)
7	ND	New data

**Bits of the output byte (control byte) 1**

Bit no.	Designation	Meaning
0	R-ACK	Read-Acknowledge
2	SFB	Send data from transmit buffer
3	CTB	Copy to transmit-buffer

**10.3.2 Detailed description of the bits (output byte 0)**

**Bit 0: Command mode: Command mode**

Output data	Description	Addr.	Data type	Value range	Default
Command mode	Command mode This bit is used to activate Command mode. In Command mode, no data is sent by the PLC to the Leuze end device via the gateway. In Command mode, various bits that execute corresponding commands depending on the selected Leuze device can be set in the data- or parameter field. For further information, see chapter 11.1.3 "Command mode".	0.0	Bit	0: Default, transparent data transmission 1: Command mode	0

The following two control bits ("Bit 1: Broadcast: Broadcast" on page 49 and "Bits 2 ... 6: Address bits 0 .. 4: address 0 .. 4" on page 49) are only relevant with a connected MA 3x. With other devices, these fields are ignored.

**Bit 1: Broadcast: Broadcast**

Output data	Description	Addr.	Data type	Value range	Default
Broadcast	Broadcast A broadcast only functions with a multiNet network connected via the MA 3x. If this bit is activated, the gateway automatically adds the broadcast command "00B" before the data. This is directed at all participants in the multiNet.	0.1	Bit	0: No broadcast 1: Broadcast	0

**Bits 2 ... 6: Address bits 0 .. 4: address 0 .. 4**

Output data	Description	Addr.	Data type	Value range	Default
Address 0..4	Address bits 0 .. 4 As with the broadcast command, individual devices in the multiNet can also be addressed via the MA 3x. In this case, the corresponding address of the device precedes the data field.telegram.	0.2 ... 0.6	Bit	00000: Addr. 0 00001: Addr. 1 00010: Addr. 2 00011: Addr. 3 ...	0

**Bit 7: New data: ND**

Output data	Description	Addr.	Data type	Value range	Default
ND	<b>New data</b> This bit is needed if several identical pieces of data are to be sent in sequence.	0.7	Bit	0->1; 1->0: On each status change for new data	0

**10.3.3 Detailed description of the bits (output byte 1)****Bit 0: Read-Acknowledge: R-ACK**

This bit is only relevant for writing slave data in blocks (Collective mode), see chapter 11.1.2.

Output data	Description	Addr.	Data type	Value range	Default
R-ACK	<b>Read-Acknowledge</b> (read confirmation) Toggle bit: Indicates to the fieldbus gateway that the "old" data has been processed and that new data can be received. At the end of a read cycle, this bit must be toggled in order to be able to receive the next data set. This toggle bit is switched by the master after valid received data has been read out of the input bytes and the next datablock can be requested. If the gateway detects a signal change in the R-ACK bit, the next bytes are automatically written from the receive buffer to the input data words and the BLR bit toggled. Further toggling erases the memory (to 00h).	1.0	Bit	0->1 or 1->0: Successfully written & ready for the next transmission	0

**Bit 2: Send data from buffer: SFB**

This bit is only relevant for writing slave data in blocks (Collective mode), see chapter 11.1.2.

Output data	Description	Addr.	Data type	Value range	Default
SFB	<b>Send data from buffer</b> (send data from the gateway transmit buffer to the RS 232) Toggle bit: changing this bit causes all data which was copied to the transmit buffer of the fieldbus gateway via the CTB bit to be transmitted to the RS 232 interface or the connected Leuze device.	1.2	Bit	0->1: Data to RS 232 1->0: Data to RS 232	0

**Bit 3: Copy to transmit buffer: CTB**

This bit is only relevant for writing slave data in blocks (Collective mode), see chapter 11.1.2.

Output data	Description	Addr.	Data type	Value range	Default
CTB	<p>Copy to transmit buffer (transmission data to transmit buffer)</p> <p>Toggle bit: Changing this bit writes the data from the PLC to the transmit buffer of the fieldbus gateway. This is used, for example, for long command strings which must be transmitted to the connected ident device.</p> <p>The CTB toggle bit is switched whenever transmit data is not to be sent directly via the serial interface, but instead transferred to the transmit buffer.</p>	1.3	Bit	<p>0-&gt;1: Data in buffer</p> <p>1-&gt;0: Data in buffer</p>	0



**Notice!**

*The state change of the CTB bit signals the MA that the data is going into the buffer; therefore, it's essential to observe the order!*

*When the CTB is not used, the telegram (which fits in one cycle) is transmitted directly to the RS 232 interface. Please make sure it is complete!*

**10.4 RESET function / deleting memory**

For many applications, it is helpful to be able to reset the MA buffer (in Collective mode) or status bits.

The following bit pattern can be transmitted from the PLC for this purpose (if >20 ms is pending):

Control byte 0: 10101010 (AAh)  
 Control byte 1: 10101010 (AAh)  
 OUT data byte 0/parameter byte 0: AAh  
 OUT data byte 1/parameter byte 1: AAh

This sets the memory or status/control bits to 00h.

Please observe that the data image may need to be updated by toggling in Collective mode.

## 11 Modes

### 11.1 Functionality of the data exchange

The fieldbus gateway has two different modes that can be selected via the PLC:

- Transparent mode (default setting)

In Transparent mode, all data are sent 1:1 and directly by the serial end device to the PLC. It is not necessary to use status and control bits here. However, only data bytes possible for **one** transmission cycle are transmitted - all others are lost.

The distance between two successive telegrams (without frame) must be more than 20ms, since there is otherwise no clear separation between them.

ASCII characters are typically expected as data content; under certain circumstances, the MA therefore detects different control characters as invalid characters in the data range and truncates them. At 00<sub>h</sub> in the data range, the MA cuts the telegram off because unnecessary bytes are also filled with 00<sub>h</sub>.

- Collective mode

In Collective mode, the data of the serial end device is stored temporarily in the fieldbus gateway by toggling the CTB bit and is not sent to the PLC in blocks until prompted to do so by the PLC.

On the PLC, a status bit (DEX) then signals that new data is ready for retrieval. This data is then read out from the fieldbus gateway in blocks (toggle bit).

In order to distinguish between the individual telegrams on the PLC, in Collective mode the serial frame is sent to the PLC in addition to the data.

The size of the buffer is 1 kByte.



#### **Notice!**

*In Collective mode, the CTB and SFB bits are needed for communication handling via the buffer. Telegrams that can also be completely transmitted in one cycle in Collective mode (including data frame) go directly through. If PLC data is provided and transferred without a state change of the CTB bit, it goes directly to the RS 232 interface with the set telegram data length. Incomplete (incl. data frame) or faulty telegrams can cause error messages in the connected device!*

*Combination with the Command mode is possible.*

*Data exchange in blocks must be programmed on the PLC.*

### 11.1.1 Reading slave data in Collective mode (gateway -> PLC)

If the Leuze device transmits data to the fieldbus gateway, the data is stored temporarily in a buffer. The PLC is signaled via the "DEX" bit that data is ready for retrieval in the memory. Data is not automatically transmitted.

If no further user data is present in the MA 255*i* ("DEX" bit = "0"), the "R-ACK" bit must be toggled once as read confirmation to release data transmission for the next read cycle.

If the buffer still contains more data ("DEX" bit = 1), the next remaining user data present in the buffer is transmitted by toggling the "R-ACK" control bit. This process is to be repeated until the "DEX" bit returns to "0"; all data has then been removed from the buffer. "R-ACK" must be toggled here again once more as a terminating read confirmation in order to release data transmission for the next read cycle.

Used status and control bits:

- DLC
- BLR
- DEX
- R-ACK

### 11.1.2 Writing slave data in Collective mode (PLC -> gateway)

#### **Writing in blocks**

The data sent by the master to the slave is first collected in a "transmit buffer" by setting the "CTB" bit (**C**opy to **t**ransmit **b**uffer). Please observe that data provided is transmitted directly by toggling the bit.

The data is then sent in the order received from the buffer to the connected Leuze device via the serial interface with the command: "SFB" (**S**end data **f**rom transmit **b**uffer). Please don't forget the suitable data frame!

Afterward, the buffer is again empty and can be written with new data.



#### **Notice!**

*With this function, it is possible to temporarily store longer data strings in the gateway independent of how many bytes the used fieldbus can transmit at once. With this function, longer PT sequences or RFID write sequences, for example, can be transmitted, since the connected devices can, in this way, receive their commands (e.g., PT or W) in a continuous string. The respective frame (STX CR LF) is needed to differentiate between the individual telegrams.*

Used status and control bits:

- CTB
- SFB

W-ACK

If PLC data is provided and transferred without a state change of the CTB bit, it goes directly to the RS 232 interface with the set telegram data length. Incomplete (incl. data frame) or faulty telegrams can cause error messages in the connected device!

**Examples for the activation of a Leuze device**

In the data part (starting at byte 2) of the telegram to the gateway, a "+" (ASCII) is sent for activation.

This means that the hex value "2B" (corresponds to a "+") is to be entered in control or output byte 2. To deactivate the reading gate, a "2D" (hex) must be used instead (corresponds to a "-" ASCII).

7	6	5	4	3	2	1	0	
ND	Address 4	Address 3	Address 2	Address 1	Address 0	Broadcast	Command mode	Control byte 0
				CTB	SFB		R-ACK	Control byte 1
Data byte 1								
Data byte 2								Data
...								

7	6	5	4	3	2	1	0	
0	0	0	0	0	0	0	0	Output byte 0
0	0	0	0	0	0	0	0	Output byte 1
0	0	0	0	0	0	B	2	Output byte 2
0	0	0	0	0	0	0	0	Output byte 3



**Collective mode sequence diagram**

Send long online commands to the DEV, read RS 232 answer from DEV

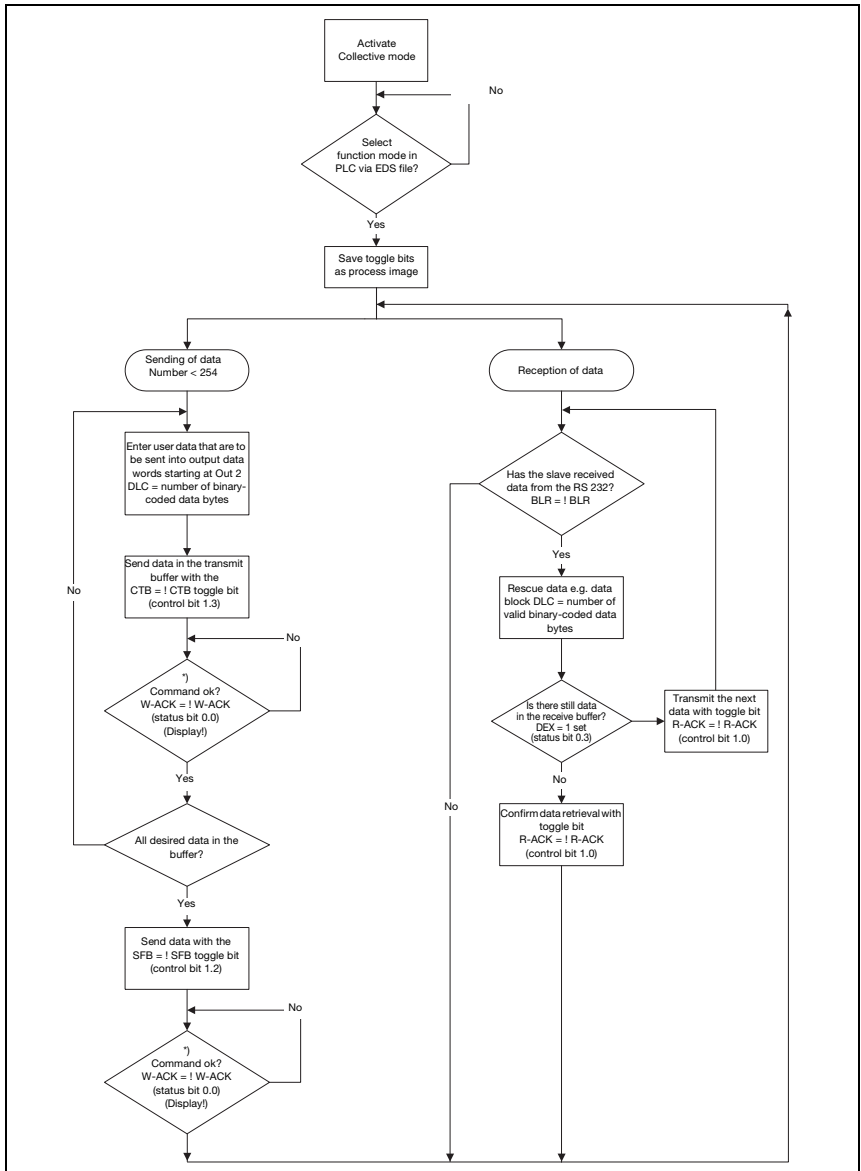

Figure 11.1: Data transmission scheme with long online commands

### 11.1.3 Command mode

One specific feature is the so-called Command mode, which is defined via the output control byte 0 (bit 0)... and enables the control of the connected device per bit.

If the Command mode is activated (Command mode = 1), no data is sent by the PLC to the Leuze end device via the gateway. The data from the MA to the PLC is transmitted in the selected operating mode (Transparent/Collective).

With the Command mode, it is possible to set various device-specific bits in the data- or parameter field that execute the corresponding serial commands (e.g., v, +, -, etc.). If, for example, the version of the Leuze end device is to be queried, the corresponding bit is to be set so that a "v" is sent to the Leuze device with the <STX> v <CR> <LF> frame.

The Leuze end device also answers the gateway with data (e.g. bar code content, NoRead, device version, etc.) in response to most commands. The answer is immediately passed on to the PLC by the gateway.



**Notice!**

*The parameters available for the individual Leuze devices are listed in chapter 16. Command mode cannot be used with hand-held scanners.*

**Examples for the activation of a Leuze device**

In Command mode, control or output byte 0.0 is to be set for activating the Command mode. Only the corresponding bit (control or output byte 2.1) then needs to be set for activating and deactivating the reading gate.

7	6	5	4	3	2	1	0	
0	0	0	0	0	0	0	1	Output byte 0
0	0	0	0	0	0	0	0	Output byte 1
0	0	0	0	0	0	1	0	Output byte 2
0	0	0	0	0	0	0	0	Output byte 3

**Command mode sequence diagram**

Set control byte 0, bit 0.0 to 1

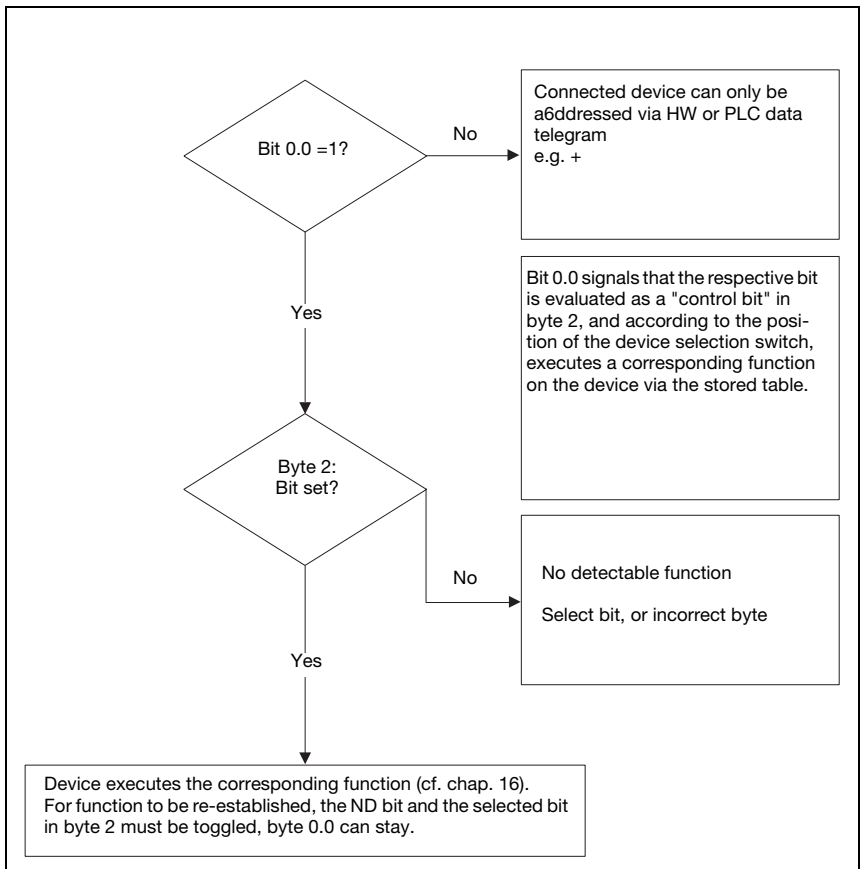

Figure 11.2: Execution of command after activation of the Command mode

**Triggering the ident devices and reading the data**

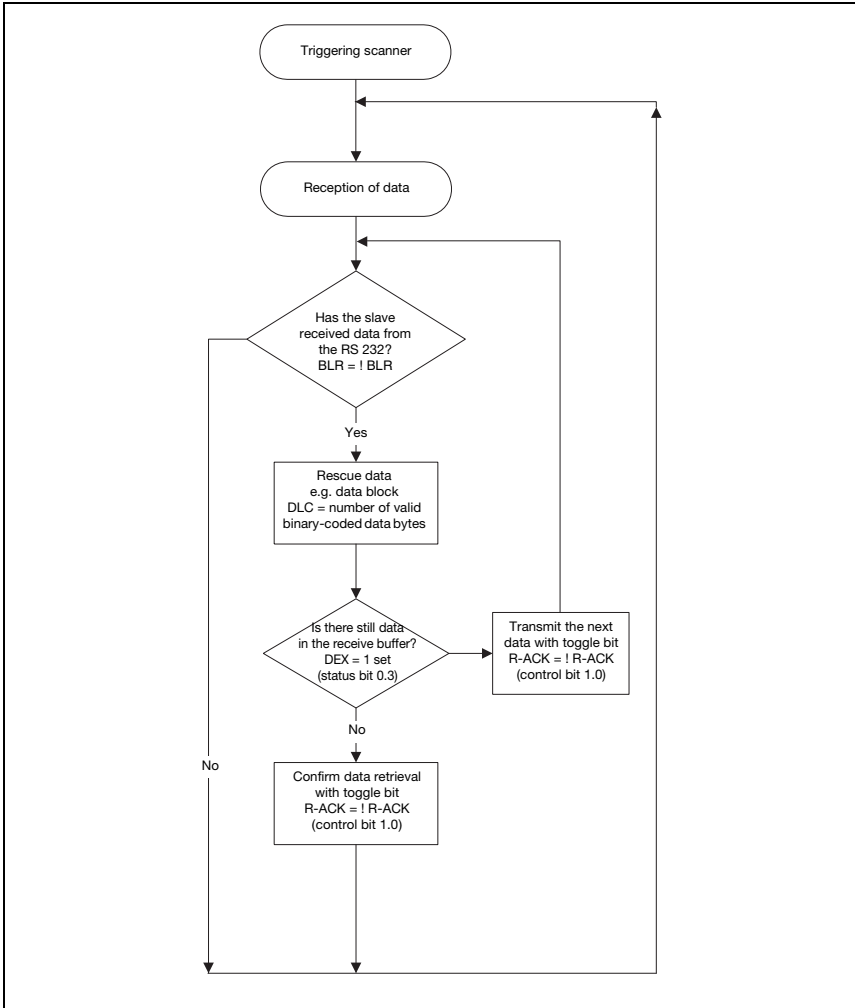

Figure 11.3: Activating DEV and reading data



**Notice!**

Further information on fieldbus telegram structure can be found in chapter 10.1. A specification of all usable commands can be found in chapter "Specifications for Leuze end devices" on page 83.

## 12 Commissioning and configuration

### 12.1 Measures to be performed prior to the initial commissioning

- ↳ Before commissioning, familiarize yourself with the operation and configuration of the MA 255*i*.
- ↳ **Before connecting the supply voltage**, recheck all connections and ensure that they have been properly made.

The Leuze device must be connected to the internal RS 232 device interface.

#### Connecting the Leuze device

- ↳ Open the housing of the MA 255*i* and guide the corresponding device cable (e.g., KB 031 for BCL 32) through the middle threaded opening.
- ↳ Connect the cable to the internal device interface (X30, X31 or X32, see chapter 7.5.1).
- ↳ Use rotary switch S4 (see chapter 8.2.5) to select the connected device.
- ↳ Now screw the PG cable gland into the threaded opening to provide strain relief and ensure protection class IP 65.

#### Set DeviceNet device address

By setting the DeviceNet address, the MA 255*i* is assigned its respective station number. Each network device is thereby automatically informed that it is a slave on the DeviceNet with its specific address and that it is initialized and queried by the PLC.

The DeviceNet permits an address range from 0 to 63. Other addresses must not be used for data communication.

- ↳ Set the station address of the gateway using the two rotary switches **S1** and **S2** (ones and tens places).

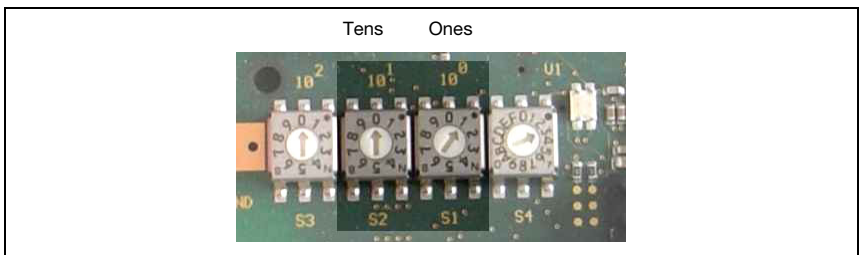

Figure 12.1: Rotary switch for setting the address

**Set DeviceNet baud rate on the MA**

The DeviceNet baud rate is defined for the entire network in the planning tool/control. The baud rate is set on the MA 255*i* via the baud rate selector switch. Only if the baud rates are the same is communication with the MA 255*i* possible.

↳ Set the baud rate of the gateway via the **S3** rotary switch to the value defined in the control.

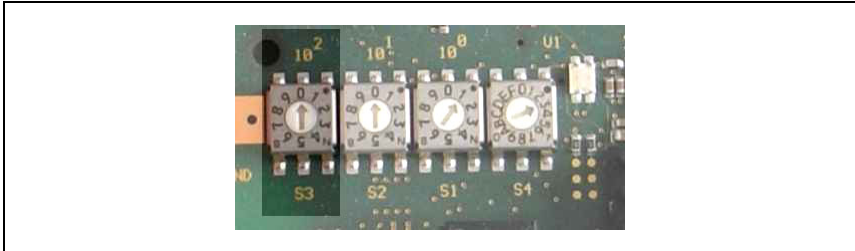

Figure 12.2: Rotary switch for setting baud rate

↳ Finally, close the housing of the MA 255*i*.



**Attention!**

Only then may the supply voltage be applied.

Upon startup of the MA 255*i*, the device selection switch and the address settings are queried and the gateway automatically sets itself to the Leuze device.

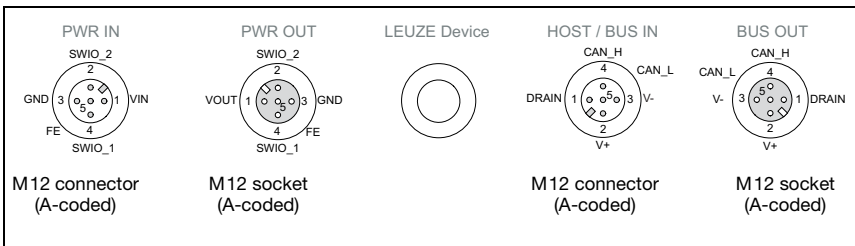

Figure 12.3: Connections of the MA 255*i* seen from below, device on mounting plate

↳ Check the applied voltage. It must be in the range between +18V ... 30VDC.

**Connecting functional earth FE**

↳ Ensure that the functional earth (FE) is connected correctly.

Unimpaired operation is only guaranteed when the functional earth is connected properly. All electrical disturbances (EMC couplings) are discharged via the functional earth connection.

On delivery, the SWIO 1/2 are connected in parallel on PWR IN/OUT. This connection can be separated with a jumper.

## 12.2 Starting the device

↳ Apply the supply voltage +18 ... 30VDC (+24VDC model); the MA 255*i* starts up.

## 12.3 Configuration steps for a Rockwell control

The following steps are necessary for commissioning with a Rockwell control:

- Creating the hardware configuration in the DeviceNet planning tool/the control (e.g. RSNetWorx)
- Installation of the EDS file
- Setting the parameters on the MA

### 12.3.1 Setting the hardware configuration

Enter the MA 255*i* in your project in the configuration of the DeviceNet system. Proceed as follows:

- ↳ First, load the EDS file for the device via EDS wizard into the PLC database.
- ↳ After loading, select the device via the device list and enter it into the HW manager via Drag&Drop.
- ↳ Open the input dialog for setting the address and additional parameters by double-clicking on the device symbol and make the desired entries here.
- ↳ Finally, transmit the values to the device via download.

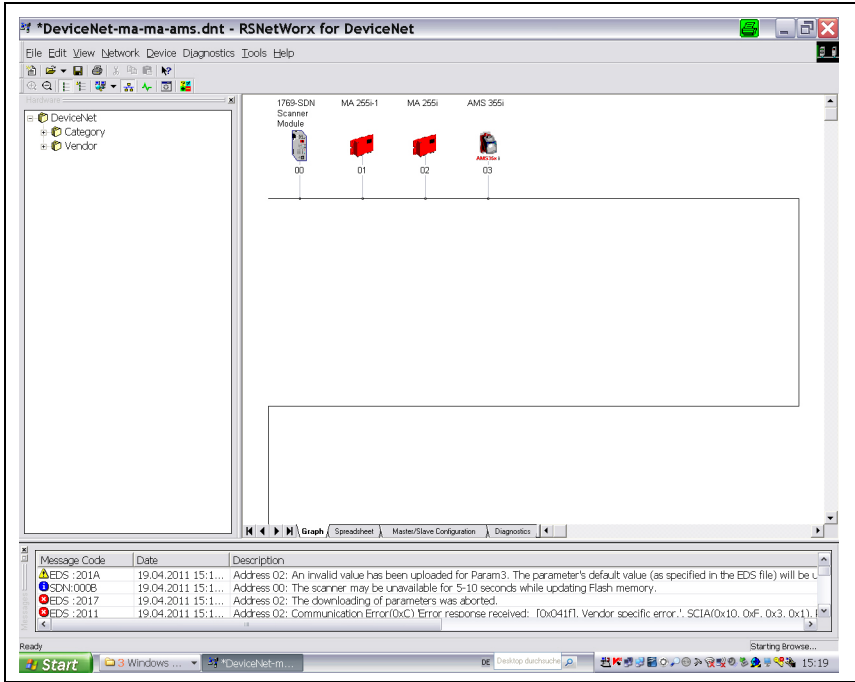

Figure 12.1: HW manager with inserted MA 255*i*



### 12.3.2 Installation of the EDS file

The MA 255*i* is configured in the planning tool/control by means of the EDS file.

↳ Install the EDS file corresponding to the MA 255*i* in your planning tool/the control (e.g., RSNNetWorx).



**Notice!**

You can find the EDS file at:

**www.leuze.com -> Download -> identify-> Modular interfacing units.**

If the MA 255*i* has been assigned an address in the planning tool, the address is to be set on the MA 255*i* via the S1 and S2 address switches, see chapter 12.1 "Measures to be performed prior to the initial commissioning", section "Set DeviceNet device address" on page 59. Only if the addresses are the same between the MA 255*i* and the control can communication be established.

### 12.3.3 Setting the parameters on the MA



**Notice!**

There are two options for changing the parameters of the MA: setting is either performed on the DeviceNet master via the scan list (communication parameters), or setting is enabled by temporarily removing the participants from the scan list. After successful parameter change, the participant can be re-added to the scan list.

This is illustrated in the following screenshot from the RSNNetWorx for DeviceNet configuration tool:

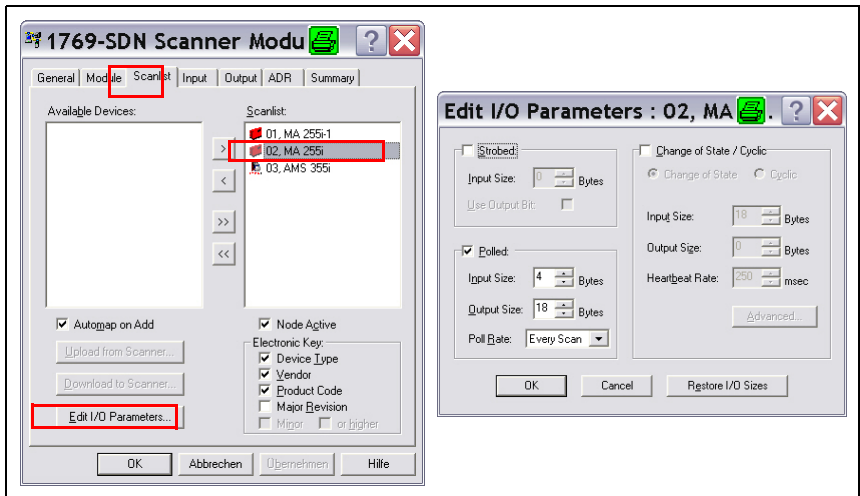

### **Variable configuration of the communication data width**

The communication of the MA 2xx*i* with the fieldbus system can be configured with a variable data width; the upper limit is restricted by the fieldbus. For DeviceNet, a value between 4 and 240 bytes (120 bytes each for input and output data) can be set.

The small data lengths (< 28 bytes) are particularly of interest for use with bar code scanners (BCL). The larger data lengths are, on the other hand, relevant for 2D code scanners (hand-held scanners, LSIS) and RFID.



#### **Notice!**

*The representation of the (Rockwell) control is usually set to double word (DINT, 4 bytes). Please observe that in this representation, the byte sequence can vary in contrast to the read code.*

After all parameters have been set in the planning tool/control, the download to the MA 255*i* takes place. The set parameters are now stored on the MA 255*i*.

Afterwards, all MA 255*i* parameters should be stored via upload in the control. This aids in retaining the parameters during device exchanges, as they are now also stored centrally in the control.

Each time a connection is established between the control and the MA 255*i*, these parameters are now transmitted again to the MA 255*i*. Note that this function must be supported by the control.

The DeviceNet baud rate is defined for the entire network in the planning tool/control. The baud rate is set on the MA 255*i* via the S3 baud rate selector switch.

Only if the baud rates are the same is communication with the MA 255*i* possible.

## **12.4 EDS file - general info**

The EDS file contains all identification and communication parameters of the device, as well as the available objects.

The MA 255*i* is uniquely classified via a class 1 identity object (component of the MA255i.eds file) for the DeviceNet master.

The identity object contains, among other things, a manufacturer-specific vendor ID, as well as an ID that describes the principle function of the participant.

The MA 255*i* has the following identity object (class 1):

Vendor ID: 524<sub>dec.</sub> / 20C<sub>H</sub>

Device type: 12<sub>dec.</sub> / 0C<sub>H</sub> (labels the MA 255*i* as "communications adapter")

Position sensor type: product type 1004 (specifies the MA 255*i* as "gateway")

The types of communication access to the data of the MA 255*i* described by the ODVA:

- Polling
- Cyclic
- Combinations of polling and cyclic

are supported by the MA 255*i*.

Communication access via **change of state** is not implemented and must not be activated in the network configuration.

If accepting the objects without change, all parameters are set to default values. The default settings are shown in the objects described in detail in the "Default" column.



**Attention!**

*The Rockwell control offers the possibility of activating the **Configuration Recovery** function. This stores the parameters defined in the EDS file in the control. If necessary, an automatic parameter download from the control to the MA 255*i* takes place.*

**Leuze electronic recommends activating "Configuration Recovery". This stores all parameters in the control.**



**Notice!**

*In the following tables, all attributes marked in the "Access" column with "Get" in the individual objects are to be understood as inputs of the MA (control). Attributes marked in the "Access" column with "Set" represent outputs or parameters.*

## 12.5 EDS file - detailed description

### 12.5.1 Class 1 Identity object

Object class 1 = 01<sub>H</sub>

Services:

- Get Attribute Single
- Reset type 0x05

Path			Designation	Size in bit	Data type	Default (dec)	Min (dec)	Max (dec)	Access
Cl.	Inst.	Attr.							
1	1	1	Vendor-Id	16	UINT	524	-	-	Get
		2	Device type	16	UINT	12	-	-	Get
		3	Product code	16	UINT	1004	-	-	Get
		4	Revision (Major, minor)	16	Struct{ USINT major, USINT minor};	Major = 1, Minor = 1	Major = 1, Minor = 1	Major = 127, Minor = 999	Get
		5	Status	16	WORD	See CiP specification (5-2.2.1.5 status)			Get
		6	Serial number	32	UDINT	Manufacturer specific			Get
		7	Product name	(max. 32) x 8	SHORT_STRING	"MA 255i"			Get

In the network configuration (e.g., RSNetWorx), it is possible to specify when entering the individual participants in the scan list which attributes of the scanner are to be monitored from the identity object.

The selection is made in the "Electronic key" field. Attributes marked there are monitored.

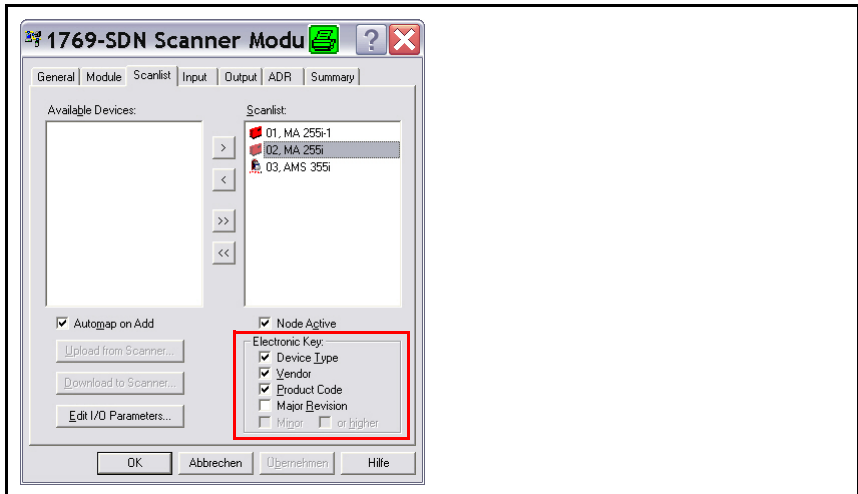

In the event of a device exchange in the system, the major revision number should **not** be monitored. The major revision number describes the firmware version of the MA 255*i* software within the EDS file/object 1. This may have changed during a possible device exchange.

**12.5.1.1 Vendor ID**

The Vendor ID assigned by ODVA for Leuze electronic GmbH + Co. KG is 524<sub>D</sub>.

**12.5.1.2 Device type**

The MA 255*i* is defined by Leuze electronic as a "communications adapter". According to ODVA, the MA 255*i* is assigned number 12<sub>D</sub> = 0C<sub>H</sub>.

**12.5.1.3 Product code**

The product code is an ID assigned by Leuze electronic that has no further impact on other objects.

**12.5.1.4 Revision**

Version number of the identity object.

**12.5.1.5 Status**

The device status is displayed in the status byte, the first part of the telegram.

Bit 7	Bit 6	Bit 5	Bit 4	Bit 3	Bit 2	Bit 1	Bit 0
ext. device state				reserved	configured	reserved	owned
Bit 15	Bit 14	Bit 13	Bit 12	Bit 11	Bit 10	Bit 9	Bit 8
reserved							

**12.5.1.6 Serial number**

For use in DeviceNet, the serial number receives a serial number converted according to CIP. CIP describes a special format for the serial number. After conversion to a CIP code, the serial number is, as before, unique, but no longer corresponds in its resolution to the serial number on the name plate.

**12.5.1.7 Product name**

This attribute contains a short designation of the product. Devices with the same product code may have different "product names".

### 12.5.2 Class 15 parameter object

Object class 15=0F<sub>H</sub>

Services:

- Get Attribute Single
- Set Attribute Single

Cl.	Path		Designation	Size in bit	Data type	Default (dec)	Min (dec)	Max (dec)	Access
	Inst.	Attr.							
15	0	Parameter object							
		1	Revision						Get
		2	Max. instance	-	UINT	8	-	-	Get
		8	Parameter class descriptor	-	UINT	0001	-	-	Get
	9	Configuration assembly instance	-	UINT	0	-	-	Get	
	1	Status byte 1							
	1	Parameter value	8	BYTE	00	-	-	Get	
	5	Data type	-	BYTE	-	-	-	Get	
	6	Data size	16	-	-	-	-	Get	
	2	Status byte 2							
	1	Parameter value	8	BYTE	00	-	-	Get	
	5	Data type	-	BYTE	-	-	-	Get	
	6	Data size	16	-	-	-	-	Get	
	3	Data bytes							
	1	Parameter value	8	BYTE	00	-	-	Get	
	5	Data type	-	BYTE	-	-	-	Get	
	6	Data size	16	-	-	-	-	Get	
	4	Data mode							
	1	Parameter value	8	BYTE	00	0	1	Set	
	5	Data type	-	UINT	0xC7	-	-	Get	
	6	Data size	16	-	2	-	-	Get	
	5	Consumed data size							
	1	Parameter value	8	BYTE	4	4	240	Set	
	5	Data type	-	UINT	0xC7	-	-	Get	
	6	Data size	16	-	2	-	-	Get	
	6	Produced data size							
	1	Parameter value	8	BYTE	18	4	240	Set	
	5	Data type	-	UINT	0xC7	-	-	Get	
	6	Data size	16	-	2	-	-	Get	
	7	Serial line mode							
	1	Parameter value	8	BYTE	0 see below	0	1	Set	
	5	Data type	-	UINT	0xC7	-	-	Get	
	6	Data size	16	-	2	-	-	Get	

Cl.	Path		Designation	Size in bit	Data type	Default (dec)	Min (dec)	Max (dec)	Access
	Inst.	Attr.							
	8		Baud rate						
		1	Parameter value	8	BYTE	96 see below	3	1152	Set
		5	Data type	-	UINT	0xC7	-	-	Get
		6	Data size	16	-	2	-	-	Get
	9		Data bits						
		1	Parameter value	8	BYTE	8 see below	7	8	Set
		5	Data type	-	UINT	0xC7	-	-	Get
		6	Data size	16	-	2	-	-	Get
	10		Parity						
		1	Parameter value	8	BYTE	1 see below	1	3	Set
		5	Data type	-	UINT	0xC7	-	-	Get
		6	Data size	16	-	2	-	-	Get
	11		Stop bits						
		1	Parameter value	8	BYTE	1 see below	1	2	Set
		5	Data type	-	UINT	0xC7	-	-	Get
		6	Data size	16	-	2	-	-	Get

### 12.5.2.1 Status byte 1 instance

Status byte 0 display

Cl.	Inst.	Attr.	Designation	Size in bit	Data type	Default (dec)	Min (dec)	Max (dec)	Access
15	1	1	Parameter value	8	BYTE	00	-	-	Get
		5	Data type	-	BYTE	-	-	-	Get
		6	Data size	16	-	-	-	-	Get

### 12.5.2.2 Status byte 2 instance

Status byte 01 display

Cl.	Inst.	Attr.	Designation	Size in bit	Data type	Default (dec)	Min (dec)	Max (dec)	Access
15	2	1	Parameter value	8	BYTE	00	-	-	Get
		5	Data type	-	BYTE	-	-	-	Get
		6	Data size	16	-	-	-	-	Get

### 12.5.2.3 Data bytes instance

Data display

Cl.	Inst.	Attr.	Designation	Size in bit	Data type	Default (dec)	Min (dec)	Max (dec)	Access
15	3	1	Parameter value	8	BYTE	00	-	-	Get
		5	Data type	-	BYTE	-	-	-	Get
		6	Data size	16	-	-	-	-	Get

### 12.5.2.4 Data mode instance

Cl.	Inst.	Attr.	Designation	Size in bit	Data type	Default (dec)	Min (dec)	Max (dec)	Access
15	4	1	Parameter value	8	BYTE	00	0	1	Set
		5	Data type	-	UINT	0xC7	-	-	Get
		6	Data size	16	-	2	-	-	Get

Parameter value:

0 = Transparent mode (default)

1 = Collective mode

### 12.5.2.5 Consumed data size instance

Cl.	Inst.	Attr.	Designation	Size in bit	Data type	Default (dec)	Min (dec)	Max (dec)	Access
15	5	1	Parameter value	8	BYTE	4	4	240	Set
		5	Data type	-	UINT	0xC7	-	-	Get
		6	Data size	16	-	2	-	-	Get

### 12.5.2.6 Produced data size instance

Cl.	Inst.	Attr.	Designation	Size in bit	Data type	Default (dec)	Min (dec)	Max (dec)	Access
15	6	1	Parameter value	8	BYTE	18	4	240	Set
		5	Data type	-	UINT	0xC7	-	-	Get
		6	Data size	16	-	2	-	-	Get

### 12.5.2.7 Serial line mode instance

Cl.	Inst.	Attr.	Designation	Size in bit	Data type	Default (dec)	Min (dec)	Max (dec)	Access
15	7	1	Parameter value	8	BYTE	0 see below	0	1	Set
		5	Data type	-	UINT	0xC7	-	-	Get
		6	Data size	16	-	2	-	-	Get

Parameter value:

0 = use rotary switch (default)

1 = use EDS settings

### 12.5.2.8 RS 232 baud rate instance

Cl.	Inst.	Attr.	Designation	Size in bit	Data type	Default (dec)	Min (dec)	Max (dec)	Access
15	8	1	Parameter value	8	BYTE	96 see below	3	1152	Set
		5	Data type	-	UINT	0xC7	-	-	Get
		6	Data size	16	-	2	-	-	Get



Parameter value:

- 3 = 300
- 6 = 600
- 12 = 1200
- 24 = 2400
- 48 = 4800
- 96 = 9600 (default)
- 192 = 19200
- 384 = 38400
- 576 = 57600
- 1152 = 115200

**12.5.2.9 RS 232 data bits instance**

Cl.	Inst.	Attr.	Designation	Size in bit	Data type	Default (dec)	Min (dec)	Max (dec)	Access
15	9	1	Parameter value	8	BYTE	8 see below	7	8	Set
		5	Data type	-	UINT	0xC7	-	-	Get
		6	Data size	16	-	2	-	-	Get

Parameter value:

- 7 = 7 bits
- 8 = 8 bits (default)

**12.5.2.10RS 232 parity instance**

Cl.	Inst.	Attr.	Designation	Size in bit	Data type	Default (dec)	Min (dec)	Max (dec)	Access
15	10	1	Parameter value	8	BYTE	1 see below	1	3	Set
		5	Data type	-	UINT	0xC7	-	-	Get
		6	Data size	16	-	2	-	-	Get

Parameter value:

- 1 = none (default)
- 2 = even
- 3 = odd

**12.5.2.11RS 232 stop bits instance**

Cl.	Inst.	Attr.	Designation	Size in bit	Data type	Default (dec)	Min (dec)	Max (dec)	Access
15	11	1	Parameter value	8	BYTE	1 see below	1	2	Set
		5	Data type	-	UINT	0xC7	-	-	Get
		6	Data size	16	-	2	-	-	Get

Parameter value:

- 1 = 1 bit (default)
- 2 = 2 bits

## 12.6 Setting the read parameters on the Leuze device

### Commissioning the Leuze device

To commission a read station, you must prepare the Leuze device on the MA 255*i* for its reading task. Communication with the Leuze device occurs via the service interface.



#### Notice!

For further information on connecting and using the service interface, see chapter 9 "Configuration".

↳ To do this, connect the Leuze device to the MA 255*i*.

Depending on the Leuze device, this occurs either via a connection cable (accessory no.: KB 031-1000) or directly on the MA 255*i*. The service connector and corresponding switches can be accessed with the housing cover open.

↳ Select the "DEV" service switch position.

### Connect the service interface; call up the terminal program

↳ Connect your PC to the service connector via the RS 232 cable.

↳ On the PC, call up a terminal program (e.g., BCL-Config) and check whether the interface (COM 1 or COM 2) to which you have connected the MA 255*i* is set to the following Leuze standard setting: 9600 baud, 8 data bits, no parity, 1 stop bit and STX, data, CR, LF.

You can download the config. tool from [www.leuze.com](http://www.leuze.com) -> **Download** -> **identify** for BCL, RFID, VR etc.

In order to communicate with the connected Leuze device, the **STX, data, CR, LF** framing must be set on the PC terminal program, as the Leuze device is preconfigured ex works for this frame character.

STX (02h):	Prefix 1
CR (0Dh):	Postfix 1
LF (0Ah):	Postfix 2

### Operation

↳ Switch the MA 255*i* to switch position "RUN" (operation).

The Leuze device is now connected to the fieldbus. Activation of the Leuze device can now occur via the switching input on the MA 255*i*, via the process data word Out-bit 1 (Bit 0.2) or by transmitting a "+" command to the Leuze device (see chapter 16 "Specifications for Leuze end devices"). For further information on the fieldbus transmission protocol, see see chapter 10 "Telegram".

### **Reading out information in service mode**

- ↳ Set the service switch of the gateway to switch position "MA" (gateway).
- ↳ Send a "v" command to call up all service information of the MA 255*i*.

An overview of the available commands and information can be found in chapter "Reading out information in service mode" on page 41.

## **12.6.1 Specific feature for the use of hand-held scanners (bar code and 2D devices, combi devices with RFID)**



### **Notice!**

For a description of device configuration and the required codes, please see the corresponding documentation at [www.leuze.com](http://www.leuze.com) -> Download -> identify -> Bar code hand-held readers or 2D code hand-held readers.

### **12.6.1.1 Cable-connected hand-held scanners on the MA 255*i***

All hand-held scanners and mobile combi devices available in the Leuze electronic product line can be used with the corresponding connection cable.

When using the MA 255*i*, the voltage supply of the hand-held scanner (5V/at 1A) can be connected to the interface by means of a cable via the 9-pin Sub-D connector (voltage on PIN 9). The corresponding cable is to be selected for the respective hand-held scanner and ordered separately. The 9-pin Sub-D cable (KB JST-HS-300, Part no. 50113397) is connected to this cable, which is connected to the MA 255*i*. This cable must also be ordered separately.

In this example, triggering occurs by means of a trigger button on the hand-held scanner.

### **12.6.1.2 Cableless hand-held scanners on the MA 255*i***

All cableless hand-held scanners and mobile combi devices available in the Leuze electronic product line can be used with the corresponding connection cable via the base station.

A 230VAC connection (socket) is usually necessary for the charging station. Here, a data connection of the charging station is established with the MA 255*i*. The corresponding cable is to be selected for the respective hand-held scanner and ordered separately. The 9-pin Sub-D cable (KB JST-HS-300, Part No. 50113397) is connected to this cable, which is connected to the MA 255*i*. This cable must also be ordered separately.

In this example, triggering occurs by means of a trigger button on the hand-held scanner.

The following codes for configuring the devices are necessary for these devices as well.

### 12.6.2 Specific features in the operation of an RFM/RFI

When using the MA 255*i* in connection with an RFID device, we recommend a data width of at least 24 bytes to be able to transmit information to or from the reader in a telegram.

Shown here is a sample telegram for a write command in combination with an RFID device.



**Notice!**

Also note that all characters which are sent to a transponder are hex-encoded ASCII characters. Each of these (hexadecimal) characters is, in turn, to be handled as an individual ASCII character and converted to hexadecimal format for transmission via the fieldbus.

**Example:**

7	6	5	4	3	2	1	0	
00	00	00	00	00	00	00	00	Control byte 0
00	00	00	00	00	00	00	00	Control byte 1
34	35	31	31	30	35	30	57	Data
00	00	34	37	33	37	35	36	

HEX	57	30	35	30	31	31	35	34	36	35	37	33	37	34
CHAR	W	0	5	0	1	1	5	4	6	5	7	3	7	4
Plain text	T e s t													

## 13 Diagnostics and troubleshooting

If problems should occur during commissioning of the MA 255*i* you can refer to the following table. Typical errors and their possible causes are described here as well as tips for their elimination.

### 13.1 General causes of errors

Error	Possible error cause	Measures
Data loss (DL bit)	Data telegram longer than the bus telegram in bus cycle/memory size.	Increase in bus telegram length. Toggle out data earlier.
Data in the RS 232 instead of in the buffer	Incorrect order.	Correct order: Provide data, toggle CTB.
<b>PWR status LED on the circuit board</b>		
Off	No supply voltage connected to the device.	Check supply voltage.
	Hardware error.	Send the device to customer service.
Green/orange, flashing	Device in boot mode.	No valid firmware, send device to customer service.
Continuous orange light	Device error.	Send the device to customer service.
	Firmware update failed.	
<b>MNS LED on the housing (see figure 8.1 on page 34)</b>		
Green, flashing	Online, no net connection.	Restart if necessary.
Red, flashing	Timeout connection.	Check address and bus connection.
Red continuous light	Communication error on the DeviceNet: No communication to controller established ("no data exchange").	Check interface. Cannot be rectified by a reset. Send the device to customer service.
	Double address.	Check address setting.
<b>PWR LED on the housing (see figure 8.1 on page 34)</b>		
Off	No supply voltage connected to the device.	Check supply voltage.
	Device not yet recognized by the DeviceNet.	Send the device to customer service.
Green, flashing	SERVICE active.	Service switch on RUN.
Red, flashing	Incorrect baud rate / address:	Check switch settings: Address switch S1, S2, Baud rate selector switch S3.
	Address >64: no communication Baud rate >4: no communication .	
Red continuous light	Device error.	Send the device to customer service.

Table 13.1: General causes of errors

## 13.2 Interface errors

**Notice!**

Please use **chapter 13 as a master copy** should servicing be required.

Cross the items in the "Measures" column which you have already examined, fill out the following address field and fax the pages together with your service contract to the fax number listed below.

**Customer data (please complete)**

<b>Device type:</b>	
<b>Company:</b>	
<b>Contact partner / department:</b>	
<b>Phone (direct):</b>	
<b>Fax:</b>	
<b>Street / No:</b>	
<b>ZIP code/City:</b>	
<b>Country:</b>	

**Leuze Service fax number:**

**+49 7021 573 - 199**

## 14 Type overview and accessories

### 14.1 Type key

MA 2xx i

Interface	i =	Integrated fieldbus technology
	04	PROFIBUS DP
	08	Ethernet TCP/IP
	35	CANopen
	38	EtherCAT
	48	PROFINET RT
	55	DeviceNet
	58	EtherNet/IP
	MA	Modular interfacing unit

### 14.2 Type overview

Type designation	Description	Description
MA 204 <i>i</i>	PROFIBUS gateway	50112893
MA 208 <i>i</i>	Ethernet TCP/IP gateway	50112892
MA 235 <i>i</i>	CANopen	50114154
MA 238 <i>i</i>	EtherCAT	50114155
MA 248 <i>i</i>	PROFINET-IO RT gateway	50112891
MA 255 <i>i</i>	DeviceNet	50114156
MA 258 <i>i</i>	EtherNet/IP	50114157

Table 14.1: Type overview MA 2xx*i*

### 14.3 Accessory terminating resistor

Type designation	Description	Part no.
TS 01-4-SA	120 ohm M12 terminating resistor for DeviceNet	50040099

Table 14.2: Accessory terminating resistor

### 14.4 Accessory connectors

Type designation	Description	Description
KD 095-5A	M12 socket for voltage supply	50020501
KS 095-4A	M12 connector for SW IN/OUT	50040155
KD 01-5-BA	M12 connector, A-coded socket, 5-pin, BUS IN	50040097
KD 01-5-SA	M12 connector, A-coded plug, 5-pin, BUS OUT	50040098

Table 14.3: Connectors for the MA 255*i*

## 14.5 Accessory ready-made cables for voltage supply

### 14.5.1 Contact assignment of PWR connection cable

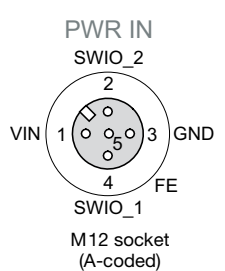
PWR IN (5-pin socket, A-coded)			
 <p>M12 socket (A-coded)</p>	Pin	Name	Core color
	1	VIN	<b>brown</b>
	2	SWIO_2	<b>white</b>
	3	GND	<b>blue</b>
	4	SWIO_1	<b>black</b>
	5	FE	<b>gray</b>
Thread	FE	<b>bare</b>	

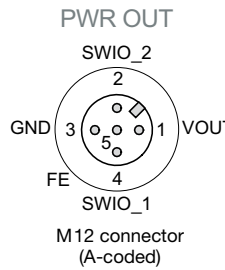
PWR OUT (5-pin connector, A-coded)			
 <p>M12 connector (A-coded)</p>	Pin	Name	Core color
	1	VOUT	<b>brown</b>
	2	SWIO_2	<b>white</b>
	3	GND	<b>blue</b>
	4	SWIO_1	<b>black</b>
	5	FE	<b>gray</b>
Thread	FE	<b>bare</b>	

### 14.5.2 Specifications of the cables for voltage supply

<b>Operating temperature range</b>	in rest state: -30°C ... +70°C
	in motion: 5°C ... +70°C
<b>Material</b>	sheathing: PVC
<b>Bending radius</b>	> 50mm



### 14.5.3 Order codes of the cables for voltage supply

Type designation	Description	Part no.
K-D M12A-5P-5m-PVC	M12 socket for PWR, axial plug outlet, open cable end, cable length 5 m	50104557
K-D M12A-5P-10m-PVC	M12 socket for PWR, axial plug outlet, open cable end, cable length 10 m	50104559

Table 14.4: PWR cables for the MA 255*i*

## 14.6 Accessory ready-made cables for bus connection

### 14.6.1 General information

- Standard cable available in lengths from 2 ... 30 m
- Special cables on request

### 14.6.2 Contact assignment of M12-DeviceNet connection cable KB DN...

DeviceNet connection cable (5-pin socket/plug, A-coded)				
	Pin	Name	Core color	Remark
<p><b>BUS OUT</b></p> <p>M12 socket (A-coded)</p>	1	Drain	-	<b>Shield</b>
	2	V+	red	<b>Supply voltage data V+</b>
	3	V-	black	<b>Supply voltage data V-</b>
	4	CAN_H	white	<b>Data signal CAN_H</b>
	5	CAN_L	blue	<b>Data signal CAN_L</b>
<p><b>BUS IN</b></p> <p>M12 connector (A-coded)</p>	Thread	FE	-	<b>Functional earth (housing)</b>

### 14.6.3 Specifications of M 12-DeviceNet connection cable KB DN...

<b>Operating temperature range</b>	in rest state:	-40°C ... +80°C
	in motion:	-5°C ... +80°C
<b>Material</b>	the cables fulfill the DeviceNet requirements, free of halogens, silicone and PVC	
<b>Bending radius</b>	> 80mm, suitable for drag chains	

### 14.6.4 Order codes of M 12-DeviceNet connection cable KB DN...

Type designation	Remark	Part no.
KB DN/CAN-2000-BA	M 12 socket for BUS IN, axial connector, open cable end, cable length 2 m	50114692
KB DN/CAN-5000-BA	M 12 socket for BUS IN, axial connector, open cable end, cable length 5 m	50114696
KB DN/CAN-10000-BA	M 12 socket for BUS IN, axial connector, open cable end, cable length 10 m	50114699
KB DN/CAN-30000-BA	M 12 socket for BUS IN, axial connector, open cable end, cable length 30 m	50114701
KB DN/CAN-2000-SA	M 12 plug for BUS OUT, axial connector, open cable end, cable length 2 m	50114693
KB DN/CAN-5000-SA	M 12 plug for BUS OUT, axial connector, open cable end, cable length 5 m	50114697
KB DN/CAN-10000-SA	M 12 plug for BUS OUT, axial connector, open cable end, cable length 10 m	50114700
KB DN/CAN-30000-SA	M 12 plug for BUS OUT, axial connector, open cable end, cable length 30 m	50114702
KB DN/CAN-1000-SBA	M 12 plug + M 12 socket for PROFIBUS, axial connectors, cable length 1 m	50114691
KB DN/CAN-2000-SBA	M 12 plug + M 12 socket for PROFIBUS, axial connectors, cable length 2 m	50114694
KB DN/CAN-5000-SBA	M 12 plug + M 12 socket for PROFIBUS, axial connectors, cable length 5 m	50114698

Table 14.5: Bus connection cable for the MA 255*i*

## 14.7 Accessory ready-made cables for connecting Leuze ident devices

### 14.7.1 Order codes for the device connection cables

Type designation	Description	Part no.
KB JST-3000	MA 31, BCL 90, IMRFU-1(RFU), cable length 3m	50115044
KB JST-HS-300	Hand-held scanner, cable length 0.3m	50113397
KB JST-M12A-5P-3000	BPS 8, BCL 8, cable length 3m	50113467
KB JST-M12A-8P-Y-3000	LSIS 4x2i, cable length 3m	50113468
KB JST-M12A-8P-3000	LSIS 122, cable length 3m	50111225
K-D M12A-5P-5m-PVC	Voltage supply, cable length 5m	50104557
K-D M12A-5P-10m-PVC	Voltage supply, cable length 10m	50104559
K-DS M12A-MA-5P-3m-S-PUR	ODS 96B with RS 232	50115049
K-DS M12A-MA-8P-3m-S-PUR	ODSL 30/D 232-M12	50115050
K-DS M12A-MA-5P-3m-1S-PUR	Konturflex Quattro RSX	50116791
KB AMS 1000 SA	AMS 200, cable length 1 m	50106978
KB 500-3000-Y	BCL 300i, BCL 500i, cable length 3m	50110240
KB 031 1000	BCL 32, cable length 1 m	50103621
KB 031 3000	BCL 32, cable length 3 m	50035355

Table 14.6: Device connection cables for the MA 255*i*



**Notice!**

The BCL 22 devices with JST connector, RFM xx and RFI xx can be connected directly with the injection molded device cable.

### 14.7.2 Contact assignment for the device connection cables

K-D M12A-5P-5000/10000 connection cable (5-pin with injection molded connector), open cable end													
		Pin	Core color										
	1	br/BN	<table border="1"> <tr><td>1</td><td>brown</td></tr> <tr><td>2</td><td>white</td></tr> <tr><td>3</td><td>blue</td></tr> <tr><td>4</td><td>black</td></tr> <tr><td>5</td><td>gray</td></tr> </table>	1	brown	2	white	3	blue	4	black	5	gray
	1	brown											
	2	white											
	3	blue											
	4	black											
5	gray												
2	ws/WH												
3	bl/BU												
4	sw/BK												
5	gr/GY												

KB JST 3000 (RS 232 connection cable, JST pin strip 10-pin, open cable end)		
Signal	Core color	JST 10-pin
TxD 232	red	5
RxD 232	brown	4
GND	orange	9
FE	shield	10

## 15 Maintenance

### 15.1 General maintenance information

The MA 255*i* does not require any maintenance by the operator.

### 15.2 Repairs, servicing

Repairs to the device must only be carried out by the manufacturer.

 *Contact your Leuze distributor or service organization should repairs be required. The addresses can be found on the inside of the cover and on the back.*



**Notice!**

*When sending devices to Leuze electronic for repair, please provide an accurate description of the error.*

### 15.3 Disassembling, packing, disposing

**Repacking**

For later reuse, the device is to be packed so that it is protected.



**Notice!**

*Electrical scrap is a special waste product! Observe the locally applicable regulations regarding disposal of the product.*

## 16 Specifications for Leuze end devices

### **Serial interface and Command mode**

The corresponding Leuze end device can be selected while configuring the fieldbus gateway (see chapter 9 "Configuration").

The exact specifications for the individual Leuze end devices can be found in the following sections and in the device description.

The corresponding serial command is sent to the Leuze end device in Command mode. To send the corresponding command to the RS 232 device after activating the Command mode in byte 0 (control bit 0.0), set the corresponding bit in byte 2.

The Leuze end device also responds to most commands by sending data, such as the bar code contents, NoRead, device version, etc., back to the gateway. The answer is not evaluated by the gateway, but is instead passed on to the PLC.

For the BPS 8, AMS and hand-held scanners, a number of specific features are to be noted.

### 16.1 Standard setting, KONTURflex (S4 switch position 0)

This switch position can be used with almost all devices, since a data frame is transmitted along with it if necessary. A 00h in the data range of the control is interpreted as the end of a telegram/invalid, however.

The distance between two successive telegrams (without frame) must be more than 20ms in this switch position, since there is otherwise no clear separation between them. If necessary, the settings have to be adjusted on the device.

Leuze measuring sensors with RS 232 interface (such as a KONTURflex Quattro RS) do not necessarily use a telegram frame, which is why these are also operated in switch position 0.

#### **Specifications for the serial interface**

Default parameter	Standard
Baud rate	9600
Data mode	8N1
Handshake	no
Protocol	framing protocol without acknowledgment
Frame	<Data>
Data mode	transparent



#### **Notice!**

*The data frame is specified via the switch position. Only the data mode and the baud rate can also be set via the EDS file.*

*In the factory setting, the S4 switch position is 0. Resetting the settings to these is possible in S4 switch position F. The procedure for doing this is described in chapter 16.14.*

### ***KONTURflex specifications***

Settings on the MA 255*i*

- DeviceNet address is freely selectable
- Device selection switch at position "0"

Settings on the DeviceNet

- Produced/Consumed data settings:  
Dependent on number of beams used, but at least "8 bytes in"
- User Parameters:  
"Transparent mode", "Use ESD settings", baud rate 38400, "8 data bits", "No parity",  
"2 stop bits"

KONTURflex settings

First, the following settings are to be performed on the device using KONTURFlex-Soft:

- Either "Autosend (fast)" or "Autosend with data in Modbus format"
- Repeat time "31.5ms"
- Autosend baud rate "38.4KB"
- 2 stop bits, no parity

## 16.2 Bar code reader BCL 8 (S4 switch position 1)

### *Specifications for the serial interface*

Default parameter	BCL 8
Baud rate	9600
Data mode	8N1
Handshake	no
Protocol	framing protocol without acknowledgment
Frame	<STX> <Data> <CR> <LF>

### *Specifications for Command mode*

To activate the Command mode, bit 0 must be set to 1 in control byte 0.

For further information, see chapter 11.1.3 "Command mode", figure 11.2.

Control bit	Meaning	Corresponds to serial command (ASCII)
0	Version query	v
1	Activation / deactivation reading gate	+ / -
2	Reference-code 1 teach-in	RT1
3	Reference-code 2 teach-in	RT2
4	Automatic configuration of reading task activation / deactivation	CA+ / CA-
5	Switching output 1 activation	OA1
6		
7	Switching output 1 deactivation	OD1
8	System standby	SOS
9	System active	SON
10	Query reflector polling	AR?
11	Output version of the boot kernel with check sum	VB
12	Output version of the decoder program with check sum	VK
13	Reset parameters to default values	PC20
14	Device restart	H

### *Recommended settings*

- Produced data: dependent on the number of digits of the bar code that is to be read.

With an 18-digit bar code (+ 2 bytes of status bytes), for example, it is advisable to use the 20-byte setting.

- Consumed data: 4 bytes

## 16.3 Bar code reader BCL 22 (S4 switch position 2)

### Specifications for the serial interface

Default parameter	BCL 22
Baud rate	9600
Data mode	8N1
Handshake	no
Protocol	framing protocol without acknowledgment
Frame	<STX> <Data> <CR> <LF>

### Specifications for Command mode

To activate the Command mode, bit 0 must be set to 1 in control byte 0.

For further information, see chapter 11.1.3 "Command mode", figure 11.2.

Control bit	Meaning	Corresponds to serial command (ASCII)
0	Version query	v
1	Activation / deactivation reading gate	+ / -
2	Reference-code 1 teach-in	RT1
3	Reference-code 2 teach-in	RT2
4	Automatic configuration of reading task activation / deactivation	CA+ / CA-
5	Switching output 1 activation	OA1
6	Switching output 2 activation	OA2
7	Switching output 1 deactivation	OD1
8	Switching output 2 deactivation	OD2
9		
10		
11	Output version of the boot kernel with check sum	VB
12	Output version of the decoder program with check sum	VK
13	Reset parameters to default values	PC20
14	Device restart	H
15		

### Recommended settings

- Produced data: dependent on the number of digits of the bar code that is to be read.

With an 18-digit bar code (+ 2 bytes of status bytes), for example, it is advisable to use the 20-byte setting.

- Consumed data: 4 bytes



## 16.4 Bar code reader BCL 32 (S4 switch position 3)

### *Specifications for the serial interface*

Default parameter	BCL 32
Baud rate	9600
Data mode	8N1
Handshake	no
Protocol	framing protocol without acknowledgment
Frame	<STX> <Data> <CR> <LF>

### *Specifications for Command mode*

To activate the Command mode, bit 0 must be set to 1 in control byte 0.

For further information, see chapter 11.1.3 "Command mode", figure 11.2.

Control bit	Meaning	Corresponds to serial command (ASCII)
0	Version query	v
1	Activation / deactivation reading gate	+ / -
2	Reference code teach-in activation / deactivation	, / .
3		
4	Automatic configuration of reading task activation / deactivation	CA+ / CA-
5	Switching output 1 activation	OA1
6	Switching output 2 activation	OA2
7	Switching output 1 deactivation	OD1
8	Switching output 2 deactivation	OD2
9		
10		
11		
12		
13		
14	Reset parameters to default values	PC20
15	Device restart	H

### *Recommended settings*

- Produced data: dependent on the number of digits of the bar code that is to be read.

With an 18-digit bar code (+ 2 bytes of status bytes), for example, it is advisable to use the 20-byte setting.

- Consumed data: 4 bytes

## 16.5 Bar code reader BCL 300i, BCL 500i (S4 switch position 4)

### Specifications for the serial interface

Default parameter	BCL 300i, BCL 500i
Baud rate	9600
Data mode	8N1
Handshake	no
Protocol	framing protocol without acknowledgment
Frame	<STX> <Data> <CR> <LF>

### Specifications for Command mode

To activate the Command mode, bit 0 must be set to 1 in control byte 0.

For further information, see chapter 11.1.3 "Command mode", figure 11.2.

Control bit	Meaning	Corresponds to serial command (ASCII)
0	Version query	v
1	Activation / deactivation reading gate	+ / -
2	Reference code teach-in activation / deactivation	RT+ / RT-
3		
4	Autom. configuration of reading task activation / deact.	CA+ / CA-
5	Switching output 1 activation	OA1
6	Switching output 2 activation	OA2
7	Switching output 1 deactivation	OD1
8	Switching output 2 deactivation	OD2
9		
10		
11		
12		
13	Parameter - difference to default parameter set	PD20
14	Reset parameters to default values	PC20
15	Device restart	H

### Recommended settings

- Produced data: dependent on the number of digits of the bar code that is to be read.

With an 18-digit bar code (+ 2 bytes of status bytes), for example, it is advisable to use the 20-byte setting.

- Consumed data: 4 bytes

## 16.6 Bar code reader BCL 90 (S4 switch position 5)

### *Specifications for the serial interface*

Default parameter	BCL 90
Baud rate	9600
Data mode	8N1
Handshake	no
Protocol	framing protocol without acknowledgment
Frame	<STX> <Data> <CR> <LF>

### *Specifications for Command mode*

To activate the Command mode, bit 0 must be set to 1 in control byte 0.

For further information, see chapter 11.1.3 "Command mode", figure 11.2.

Control bit	Meaning	Corresponds to serial command (ASCII)
0	Version query	v
1	Activation / deactivation reading gate	+ / -
2	Configuration mode	11
3	Alignment mode	12
4	Read operation	13
5		
6		
7		
8		
9		
10		
11		
12		
13		
14	Reset parameters to default values	PC20
15	Device restart	H

### *Recommended settings*

- Produced data: dependent on the number of digits of the bar code that is to be read.

With an 18-digit bar code (+ 2 bytes of status bytes), for example, it is advisable to use the 20-byte setting.

- Consumed data: 4 bytes

## 16.7 LSIS 122 (S4 switch position 6)

### Specifications for the serial interface

Default parameter	LSIS 122
Baud rate	9600
Data mode	8N1
Handshake	no
Protocol	framing protocol without acknowledgment
Frame	<STX> <Data> <CR> <LF>

### Specifications for Command mode

To activate the Command mode, bit 0 must be set to 1 in control byte 0.

For further information, see chapter 11.1.3 "Command mode", figure 11.2.

Control bit	Meaning	Corresponds to serial command (ASCII)
0	Version query	i
1	Activation/Deactivation of reading gate: 12h/14h	<DC2> / <DC4>
2		
3		
4		
5		
6		
7		
8		
9		
10		
11		
12		
13		
14		
15		

### Recommended settings

- Produced data: dependent on the number of digits of the 2D code that is to be read.

With an 18-digit code (+ 2 bytes of status bytes), for example, it is advisable to use the 20-byte setting.

- Consumed data: 4 bytes

## 16.8 LSIS 4x2i (S4 switch position 7)

### *Specifications for the serial interface*

Default parameter	LSIS 4x2i
Baud rate	9600
Data mode	8N1
Handshake	no
Protocol	framing protocol without acknowledgment
Frame	<STX> <Data> <CR> <LF>

### *Specifications for Command mode*

To activate the Command mode, bit 0 must be set to 1 in control byte 0.

For further information, see chapter 11.1.3 "Command mode", figure 11.2.

Control bit	Meaning	Corresponds to serial command (ASCII)
0	Version query	v
1	Image acquisition trigger	+
2		
3		
4		
5		
6		
7		
8		
9		
10		
11		
12		
13		
14		
15		

### *Recommended settings*

- Produced data: dependent on the number of digits of the 2D code that is to be read.

With an 18-digit code (+ 2 bytes of status bytes), for example, it is advisable to use the 20-byte setting.

- Consumed data: 4 bytes

## 16.9 Hand-held scanner (S4 switch position 8)

### *Specifications for the serial interface*

Default parameter	Hand-held scanner
Baud rate	9600
Data mode	8N1
Handshake	no
Protocol	framing protocol without acknowledgment
Frame	<Data> <CR> <LF>



#### **Notice!**

*Command mode cannot be used with hand-held scanners.*

#### **Recommended settings**

- Produced data: dependent on the number of digits of the code that is to be read.

With an 12-digit bar code (+ 2 bytes of status bytes), for example, it is advisable to use the 20-byte setting.

- Consumed data: none

## 16.10 RFI, RFM, RFU RFID readers (S4 switch position 9)

### Specifications for the serial interface

Default parameter	RFM 12,RFM 32 and RFM 62 RFI 32 RFU (via IMRFU)
Baud rate	9600
Data mode	8N1
Handshake	no
Protocol	framing protocol without acknowledgment
Frame	<STX> <Data> <CR> <LF>

### Specifications for Command mode

To activate the Command mode, bit 0 must be set to 1 in control byte 0.

For further information, see chapter 11.1.3 "Command mode", figure 11.2.

Control bit	Meaning	Corresponds to serial command (ASCII)
0	Version query	v
1	Activation / deactivation reading gate	+ / -
2		
3		
4		
5		
6		
7		
8		
9		
10		
11		
12		
13		
14	Reset parameters to default values	R <sup>1)</sup>
15	Device restart	H

1) Not for IMRFU/RFU

### Recommended settings

- Produced data: dependent on the number of digits of the RFID code that is to be read.

For example, it is advisable to use the produced data/consumed data setting with 24 bytes during the reading of a serial number with 16 characters (+ 2 bytes of status bytes).

- Consumed data: 4 bytes

If data are to be written, it is advisable to use the setting with 24 bytes or 32 bytes. The RFID devices expect the telegrams / data in HEX format.

## 16.11 BPS 8 bar code positioning system (S4 switch position A)

### Specifications for the serial interface

Default parameter	BPS 8
Baud rate	57600
Data mode	8N1
Handshake	no
Protocol	binary protocol without acknowledgment
Frame	<Data>

### Specifications for Command mode

To activate the Command mode, bit 0 must be set to 1 in control byte 0.

For further information, see chapter 11.1.3 "Command mode", figure 11.2.

Control bit	Meaning	Corresponds to serial command (HEX)	
		byte 1	byte 2
0	Request diagnostic info	01	01
1	Request marker info	02	02
2	Request SLEEP mode	04	04
3	Request position info	08	08
4	Request individual measurement	10	10
5			
6			
7			
8			
9			
10			
11			
12			
13			
14			
15			

### Recommended settings

- Produced data: 8 bytes
- Consumed data: 4 bytes

In this switch position, the MA automatically sends a position request to the BPS 8 every 10ms until another command comes via the control. Automatic request only restarts when a new position request is sent by the PLC or when the MA is restarted.



**16.12 AMS distance measurement device, ODSL xx optical distance sensors with RS 232 interface (S4 switch position B)**



**Notice!**

*In this switch position, 6-byte data (fixed) is always expected by the device. This is why a quick telegram sequence can be transmitted reliably even without a data frame.*

**AMS**

**Specifications for the serial interface**

Default parameter	AMS
Baud rate	38400
Data mode	8N1
Handshake	no
Protocol	binary protocol without acknowledgment
Frame	<Data>

**Specifications for Command mode**

To activate the Command mode, bit 0 must be set to 1 in control byte 0.

For further information, see chapter 11.1.3 "Command mode", figure 11.2.

Control bit	Meaning	Corresponds to serial command (HEX)
0	Transmit individual position value = single shot	C0F131
1	Cyclically transmit position values	C0F232
2	Stop cyclical transmission	C0F333
3	Laser diode on	C0F434
4	Laser diode off	C0F535
5	Transmit single speed value	C0F636
6	Cyclically transmit speed values	C0F737
7		
8		
9		
10		
11		
12		
13		
14		
15		

**Recommended settings**

- Produced data: 8 bytes
- Consumed data: 8 bytes

## ODSL 9, ODSL 30 and ODSL 96B



### **Notice!**

The default settings of the ODS serial interface have to be adjusted! Further information on configuration of the interface can be found in the technical description of the corresponding device.

### **Specifications for the serial interface**

Default parameter	AMS
Baud rate	38400
Data mode	8N1
Handshake	no
Protocol	ASCII transmission, 5-digit measurement value
Frame	<Data>

### **Specifications for Command mode**

Command mode cannot be used with the ODSL 9, ODSL 30 and ODSL 96B.

The ODSL 9/96B is to be operated in the "Precision" measure mode. The mode is set through the display menu via `Application -> Measure mode -> Precision`. You can find more details on this in the technical description.

### 16.13 Modular interfacing unit MA 3x (S4 switch position C)

**Specifications for the serial interface**

Default parameter	MA 3x
Baud rate	9600
Data mode	8N1
Handshake	no
Protocol	framing protocol without acknowledgment
Frame	<STX> <Data> <CR> <LF>

**Specifications for Command mode**

To activate the Command mode, bit 0 must be set to 1 in control byte 0.

For further information, see chapter 11.1.3 "Command mode", figure 11.2.

Control bit	Meaning	Corresponds to serial command (ASCII)
0	Version query	v
1		
2		
3		
4		
5		
6		
7		
8		
9		
10		
11		
12		
13		
14	Reset parameters to default values	PC20
15	Device restart	H

**Recommended settings**

- Produced data: dependent on the number of digits of the code that is to be read.

With an 18-digit bar code (+ 2 bytes of status bytes + 2 bytes of slave address), for example, it is advisable to use the 24-byte setting.

- Consumed data: 4 bytes



**Notice!**

*In this switch position, the address of the multiNet slave is also transmitted in the first two bytes of the data range!*

## 16.14 Resetting the parameters (S4 switch position F)

To reset all parameters of the MA that can be configured with software (such as baud rate, IP address, dependent on type) to the factory settings, do the following:

- ↳ *Set device switch S4 to F in a voltage free state.*
- ↳ *Switch the voltage on and wait until it is ready for operation.*
- ↳ *If necessary, switch the voltage off to prepare for commissioning.*
- ↳ *Set service switch S10 to the "RUN" position.*

**17 Appendix**

**17.1 ASCII table**

HEX	DEC	CTRL	ABB	DESIGNATION	MEANING
00	0	^@	NUL	NULL	Null
01	1	^A	SOH	START OF HEADING	Start of heading
02	2	^B	STX	START OF TEXT	Start of text characters
03	3	^C	ETX	END OF TEXT	Last character of text
04	4	^D	EOT	END OF TRANSMISSION	End of transmission
05	5	^E	ENQ	ENQUIRY	Request to transmit data
06	6	^F	ACK	ACKNOWLEDGE	Positive acknowledgment
07	7	^G	BEL	BELL	Bell signal
08	8	^H	BS	BACKSPACE	Backspace
09	9	^I	HT	HORIZONTAL TABULATOR	Horizontal tabulator
0A	10	^J	LF	LINE FEED	Line feed
0B	11	^K	VT	VERTICAL TABULATOR	Vertical tabulator
0C	12	^L	FF	FORM FEED	Form feed
0D	13	^M	CR	CARRIAGE RETURN	Carriage return
0E	14	^N	SO	SHIFT OUT	Shift out
0F	15	^O	SI	SHIFT IN	Shift in
10	16	^P	DLE	DATA LINK ESCAPE	Data link escape
11	17	^Q	DC1	DEVICE CONTROL 1 (X-ON)	Device control character 1
12	18	^R	DC2	DEVICE CONTROL 2 (TAPE)	Device control character 2
13	19	^S	DC3	DEVICE CONTROL 3 (X-OFF)	Device control character 3
14	20	^T	DC4	DEVICE CONTROL 4	Device control character 4
15	21	^U	NAK	NEGATIVE (/Tape) ACKNOWLEDGE	Negative acknowledge
16	22	^V	SYN	SYNCHRONOUS IDLE	Synchronization
17	23	^W	ETB	END OF TRANSMISSION BLOCK	End of data transmission bloc
18	24	^X	CAN	CANCEL	Invalid
19	25	^Y	EM	END OF MEDIUM	End of medium
1A	26	^Z	SUB	SUBSTITUTE	Substitution
1B	27	^[	ESC	ESCAPE	Escape
1C	28	^\ ^]	FS GS	FILE SEPARATOR GROUP SEPARATOR	File separator Group separator
1D	29	^]	GS	GROUP SEPARATOR	Group separator
1E	30	^^	RS	RECORD SEPARATOR	Record separator
1F	31	^_ ^_	US US	UNIT SEPARATOR	Unit separator
20	32		SP	SPACE	Space
21	33		!	EXCLAMATION POINT	Exclamation point
22	34		"	QUOTATION MARK	Quotation mark
23	35		#	NUMBER SIGN	Number sign
24	36		\$	DOLLAR SIGN	Dollar sign
25	37		%	PERCENT SIGN	Percent sign
26	38		&	AMPERSAND	Ampersand
27	39		'	APOSTROPHE	Apostrophe
28	40		(	OPENING PARENTHESIS	Opening parenthesis

HEX	DEC	CTRL	ABB	DESIGNATION	MEANING
29	41		)	CLOSING PARENTHESIS	Closing parenthesis
2A	42		*	ASTERISK	Asterisk
2B	43		+	PLUS	Plus sign
2C	44		,	COMMA	Comma
2D	45		-	HYPHEN (MINUS)	Hyphen (minus)
2E	46		.	PERIOD (DECIMAL)	Period (decimal)
2F	47		/	SLANT	Slant
30	48		0		
31	49		1		
32	50		2		
33	51		3		
34	52		4		
35	53		5		
36	54		6		
37	55		7		
38	56		8		
39	57		9		
3A	58		:	COLON	Colon
3B	59		;	SEMICOLON	Semicolon
3C	60		<	LESS THAN	Less than
3D	61		=	EQUALS	Equals
3E	62		>	GREATER THAN	Greater than
3F	63		?	QUESTION MARK	Question mark
40	64		@	COMMERCIAL AT	Commercial AT
41	65		A		
42	66		B		
43	67		C		
44	68		D		
45	69		E		
46	70		F		
47	71		G		
48	72		H		
49	73		I		
4A	74		J		
4B	75		K		
4C	76		L		
4D	77		M		
4E	78		N		
4F	79		O		
50	80		P		
51	81		Q		
52	82		R		
53	83		S		
54	84		T		
55	85		U		
56	86		V		
57	87		W		
58	88		X		

HEX	DEC	CTRL	ABB	DESIGNATION	MEANING
59	89		Y		
5A	90		Z		
5B	91		[	OPENING BRACKET	Opening bracket
5C	92		\	REVERSE SLANT	Reverse slant
5D	93		]	CLOSING BRACKET	Closing bracket
5E	94		^	CIRCUMFLEX	Circumflex
5F	95		_	UNDERSCORE	Underscore
60	96		`	GRAVE ACCENT	Grave accent
61	97		a		
62	98		b		
63	99		c		
64	100		d		
65	101		e		
66	102		f		
67	103		g		
68	104		h		
69	105		i		
6A	106		j		
6B	107		k		
6C	108		l		
6D	109		m		
6E	110		n		
6F	111		o		
70	112		p		
71	113		q		
72	114		r		
73	115		s		
74	116		t		
75	117		u		
76	118		v		
77	119		w		
78	120		x		
79	121		y		
7A	122		z		
7B	123		{	OPENING BRACE	Opening brace
7C	124			VERTICAL LINE	Vertical line
7D	125		}	CLOSING BRACE	Closing brace
7E	126		~	TILDE	Tilde
7F	127		DEL	DELETE (RUBOUT)	Delete

**A**

Accessories .....	77
Bus connection cables .....	79
Cables for Leuze ident devices .....	81
Connector .....	77
Voltage supply cables .....	78
Areas of application for the fieldbus gateway	9
ASCII table .....	99

**C**

Causes of errors	
General .....	75
Interface .....	76
Collective mode .....	15
Command mode .....	15, 56
Commissioning .....	59
Configuration .....	41, 59
Connecting the Leuze device .....	12
PCB connectors X30 ... X32 .....	38
Connections	
PWR IN .....	28
PWR OUT switching input/output .....	30
Control bytes .....	48

**D**

Declaration of conformity .....	6
Definition of Terms .....	8
Description of functions .....	7
Device description .....	15
Device interface RS 232 .....	32
Diagnostics .....	75
Dimensioned drawings .....	22
Disassembling .....	82
Disposing .....	82

**E**

Electrical connection .....	11
Connecting the Leuze device .....	12
Power supply and bus cable .....	13
Safety notices .....	27

**F**

Fast commissioning .....	11
Fieldbus systems .....	18

**I**

Input byte 0	
Buffer overflow .....	47
Data exist .....	46
Data loss .....	47
New data .....	48
Next block ready to transmit .....	47
Service mode active .....	46
Write-Acknowledge .....	46
Input byte 1	
Data length code .....	48
Intended use .....	9
Interface	
DeviceNet .....	32

**L**

LED status indicators .....	34
Leuze device	
2D code reader	
LSIS 122 .....	90
LSIS 4x2i .....	91
Bar code positioning system (BPS)	
BPS 8 .....	94
Bar code reader (BCL)	
BCL 22 .....	86
BCL 300i .....	88
BCL 32 .....	87
BCL 500i .....	88
BCL 8 .....	85
BCL 90 .....	89
Distance measurement device	
AMS .....	95
Hand-held scanner .....	92
RFID read-write devices (RFM/RFI ...)	
RFM 12, 32 and 62 .....	93
Setting the read parameters .....	72
Specific feature for hand-held scanners	73
Specifications for Command mode .....	83
Specifications for the serial interface .....	83
<b>M</b>	
Maintenance .....	82
Mounting	
Device arrangement, selecting a mounting location .....	11, 26
Mounting the device .....	11, 25



**O**

Operating modes  
   Operation ..... 17  
   Service fieldbus gateway ..... 17  
   Service Leuze device ..... 17  
 Output byte 0  
   Address bits 0 .. 4 ..... 49  
   Broadcast ..... 49  
   Command mode ..... 49  
   New data ..... 50  
 Output byte 1  
   Copy to transmit buffer ..... 51  
   Read-Acknowledge ..... 50  
   Send data from buffer ..... 50

**P**

Packing ..... 82

**Q**

Quality assurance ..... 6

**R**

Reading slave data ..... 53  
 Repair ..... 9, 82

**S**

Safety notices ..... 9  
 Service interface ..... 33, 38  
 Service mode  
   Commands ..... 42  
   Information ..... 42  
 Service switch ..... 38  
 Servicing ..... 82  
 Setting the DeviceNet device address ..... 12  
 Specifications ..... 21  
   Electrical data ..... 21  
   Environmental data ..... 21  
   Indicators ..... 21  
   Mechanical data ..... 21  
 Starting the device ..... 14, 61  
 Status bytes ..... 45  
 Structure of the fieldbus telegram ..... 44  
 Symbols ..... 6

**T**

Telegram structure  
   Input bytes ..... 45  
   Output bytes ..... 48  
 Transparent mode ..... 15  
 Troubleshooting ..... 75  
 Type overview ..... 23, 77

**W**

Writing slave data ..... 53