

PRK 8

Retro-reflective photoelectric sensors with tracking function

en 06-2014/04 50125971



0 ... 2.4m
1 kHz
Tracking
 PET
 Glas
10 - 30 V
DC

- Detection of transparent media (e. g. clear glass, PE, foil)
- Automatic contamination compensation (tracking function) for longer intervals between cleanings
- The autocollimation principle used ensures that the device functions reliably over the entire range (0 ... max.)
- Push-pull switching outputs
- M12 turning connector
- Visible red light

Dimensioned drawing

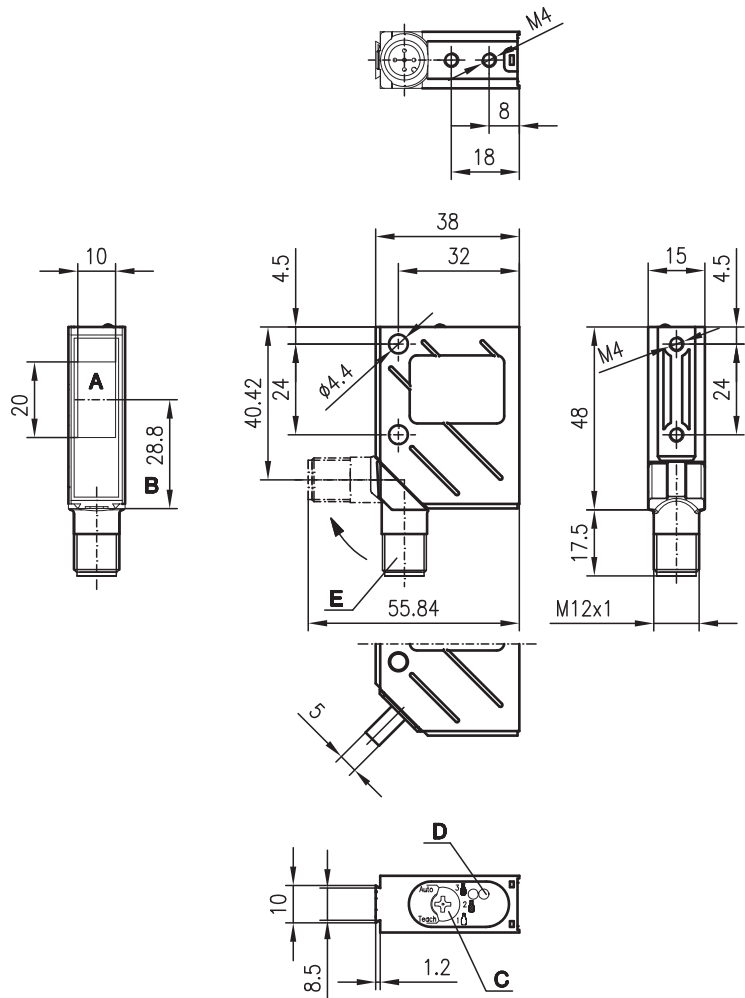

- A** Receiver
- B** Optical axis
- C** Operational control
- D** LED yellow, LED green
- E** 90° turning connector

Electrical connection

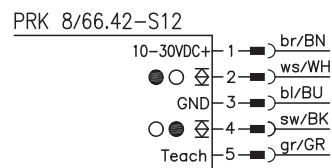

We reserve the right to make changes • DS_PRK8_6642_en_50125971.fm

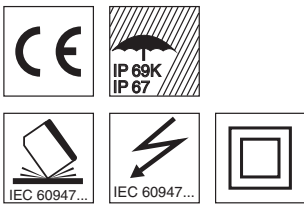

Accessories:

- (available separately)
- M12 connectors (KD ...)
 - Ready-made cables (K-D ...)
 - Mounting systems
 - Reflectors
 - Reflective tapes
 - Control guard

Specifications

Optical data

Typ. operating range limit (TK(S) 100x100) ¹⁾	0 ... 2.4m
Operating range ²⁾	see tables
Recommended reflector	MTK(S) 50x50
Light source	LED (modulated light)
Wavelength	660nm (visible red light)
Light spot	square, focussed at 200mm

Timing

Switching frequency	1000Hz
Response time	0.5ms
Delay before start-up	≤ 650ms

Electrical data

Operating voltage U_B	10 ... 30VDC
Residual ripple	≤ 15% of U_B
Bias current	≤ 35mA
Switching output/function	2 push-pull switching outputs ³⁾ pin 2: PNP dark switching, NPN light switching pin 4: PNP light switching, NPN dark switching
	≥ ($U_B - 2V$) / ≤ 2V
	max. 100mA
	adjustable with step switch
Signal voltage high/low	
Output current	
Sensitivity	

Switch positions

Position teach-in	activation of the teach procedure
Position 1 (PE bottle)	operating point PE bottle
Position 2 (clear glass bottle)	operating point clear glass bottle
Position 3 (coloured glass bottle)	operating point coloured glass bottle
Position Auto	tracking ON/OFF

Indicators

LED green	ready, user acknowledge
LED green flashing	Teach process running, switching to AUTO
LED yellow	light path free, status display tracking function
LED yellow flashing	device error, teach error, no performance reserve

Mechanical data

Housing	metal
Optics cover	glass
Weight	70g
Connection type	M12 connector, 5-pin (turning)

Environmental data

Ambient temp. (operation/storage)	-40°C ... +60°C / -40°C ... +70°C
Protective circuit ⁴⁾	2, 3
VDE safety class ⁵⁾	II, all-insulated
Protection class ⁶⁾	IP 67, IP 69K ⁷⁾
Light source	free group (in acc. with EN 62471)
Standards applied	IEC 60947-5-2

Options

Teach input	
Active/not active	edge from 0V to U_B /0V or floating
Teach delay	< 500ms

- 1) Typ. operating range limit: max. attainable range without performance reserve
- 2) Operating range: recommended range with performance reserve
- 3) The push-pull switching outputs must not be connected in parallel
- 4) 2=polarity reversal protection, 3=short-circuit protection for all outputs
- 5) Rating voltage 250VAC
- 6) In stop position of the turning connector (turning connector locked)
- 7) IP 69K test acc. to DIN 40050 part 9 simulated, high pressure cleaning conditions without the use of additives, acids and bases are not part of the test

Order guide

	Designation	Part No.
With M12 connector	PRK 8/66.42-S12	50037135

Tables

Reflectors			Operating range
1	TK(S)	100x100	0 ... 2.0m
2	MTK(S)	50x50.1	0 ... 1.5m
3	TK(S)	30x50	0 ... 0.6m
4	TK(S)	20x40	0 ... 0.6m
5	Tape 6	50x50	0 ... 1.0m

1	0	2.0	2.4
2	0	1.5	1.8
3	0	0.6	0.8
4	0	0.6	0.8
5	0	1.0	1.2

- Operating range [m] *
- Typ. operating range limit [m] *

*) For sensitivity set to operating point 3

TK ... = adhesive
TKS ... = screw type
Tape 2 = adhesive

Diagrams

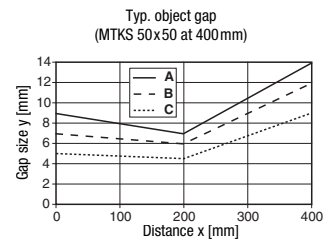

- A Switch position 1
- B Switch position 2
- C Switch position 3

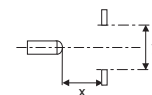

Remarks

- **Approved purpose:**
This product may only be used by qualified personnel and must only be used for the approved purpose. This sensor is not a safety sensor and is not to be used for the protection of persons.
- **Reflectors:**
The light spot may not extend beyond the reflector. Preferably use MTK(S) reflectors or reflective tape 6.
- Note the light spot geometry and installation conditions

PRK 8

1. Operating principle of contamination compensation (tracking function)

This transparency sensor (clear-glass sensor) is a device which automatically compensates system contamination at the reflector and sensor by means of continuous measurement of the receiving level. The control rate depends on the number of gaps in the process. This tracking function increases the interval between cleaning sessions considerably.

The sensor does not need to be recalibrated after the system has been cleaned. In typical applications, cleaning can be performed during system operation. This means higher system efficiency.

The system is calibrated ("teach-in") once only at initial setup. The appropriate object is then selected (PE, clear glass or coloured glass). The "teach-in" process does not have to be performed again if a different object is selected.

2. Controls and indicators

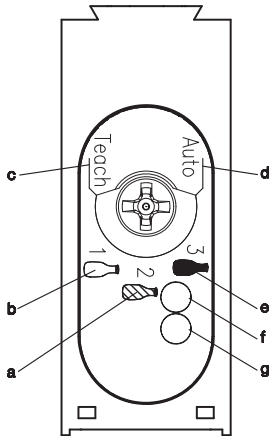

- a Switch position 2 (clear-glass bottle)
- b Switch position 1 (PE bottle, glass pane, foil)
- c Switch position Teach
- d Switch position, tracking ON/OFF
- e Switch position 3 (coloured-glass bottle)
- f Operation and teach indicator (LED green)
- g Light path free (LED yellow)

3. Adjustment procedure (teach-in) via step switch

	Correct adjustment procedure:	Important to note:
	<ol style="list-style-type: none"> 1. There must be no objects in the beam path between the retro-reflective photoelectric sensor and the reflector during the adjustment procedure. 2. Align the sensor with the reflector so that the beam is visible in the middle of the reflector 	<p>The teach-in procedure must be conducted without any objects!</p> <p>The beam must not fall outside the reflector area. The mounted reflector should always be larger than the visible beam!</p>
	<ol style="list-style-type: none"> 3. Turn the step switch to the "Teach" position for about 2s. 4. Turn the step switch back to positions 1, 2 or 3. 5. To turn the tracking function on/off, turn the step switch to "Auto" for about 10s. 6. Turn the step switch back to positions 1, 2 or 3. 	<p>The adjustment procedure must be conducted without objects!</p> <p>The step switch must be turned to positions 1, 2 or 3 during operation!</p>

4. Setting operating mode

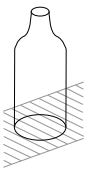
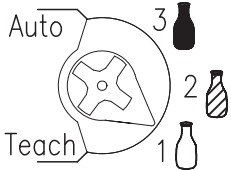
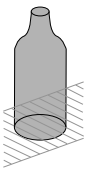
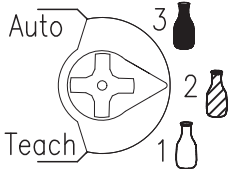
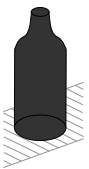
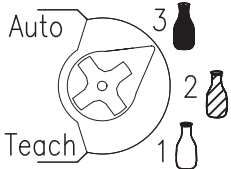
Object to be identified	Material, e.g.:	Switch position	Correct adjustment procedure:
① Transparent objects 	<ul style="list-style-type: none"> ● PE bottle ● PEN bottle ● Clear plate glass ● Foil 		<ol style="list-style-type: none"> 1. Turn the step switch to the "Teach" position for about 2s. 2. Turn the step switch back to position 1 <p>Tracking can be turned on or off by switching to "Auto"</p>
≙ Less transparent objects 	<ul style="list-style-type: none"> ● Clear glass bottle ● Coloured plate glass 		<ol style="list-style-type: none"> 1. Turn the step switch to the "Teach" position for about 2s. 2. Turn the step switch back to position 2 <p>Tracking can be turned on or off by switching to "Auto"</p>
≙ Opaque objects 	<ul style="list-style-type: none"> ● Coloured glass bottle ● Opaque objects 		<ol style="list-style-type: none"> 1. Turn the step switch to the "Teach" position for about 2s. 2. Turn the step switch back to position 3 <p>Tracking can be turned on or off by switching to "Auto"</p>

5. Calibration procedure (teach-in) by wire

1. Set step switch to desired operating mode (PE, clear-glass or coloured-glass bottle).
2. Activate teach-in wire (pin 5, edge triggered from 0V to U_B).
3. Deactivate teach-in wire (pin 5).

6. Switching the tracking function on or off

	Operation	LED green	LED yellow
1	Step switch is in position 1, 2, or 3	ON	ON or OFF depending on switching state
2	Set step switch from 1, 2, or 3 -> Auto	OFF	ON or OFF depending on switching state
3	Status display of the tracking function	6Hz	Status display: ON=tracking active OFF=tracking not active
4	Delay before switching: 10s After 10s, the tracking is changed	6Hz	Status display: ON=tracking active OFF=tracking not active
5	Set step switch from Auto -> 1, 2, or 3	ON	ON/OFF