

PRKL 3B Laser-retro-reflective photoel. sensors with polariz. filter for bottles

en 03-2012/08 50115107

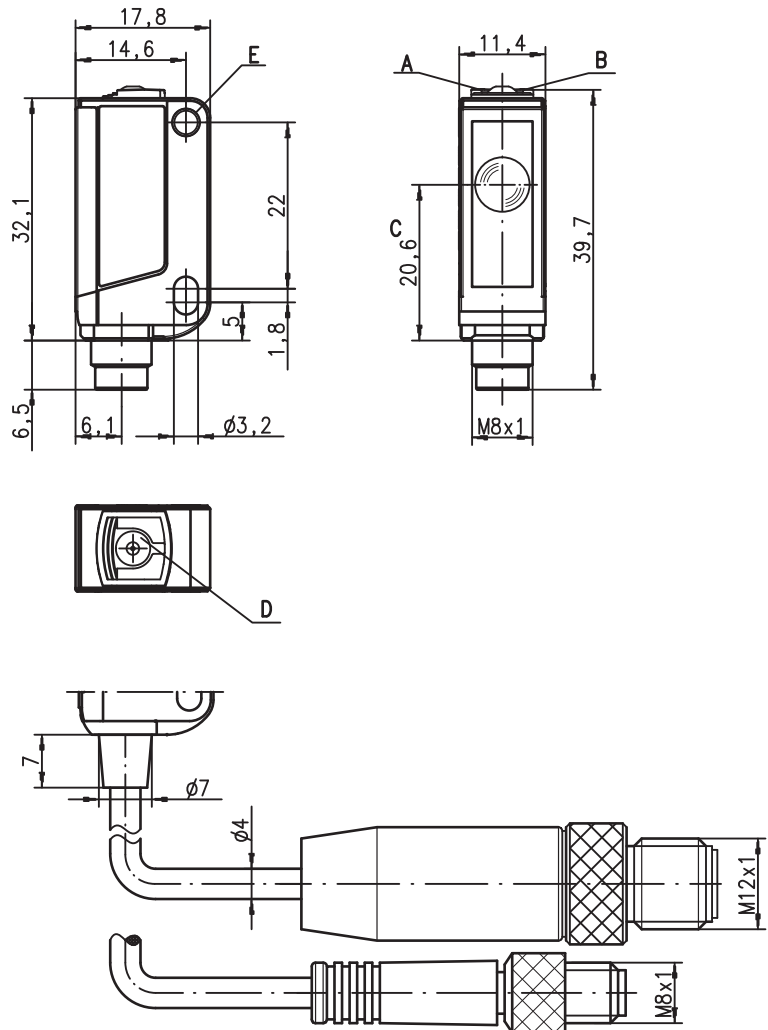

Dimensioned drawing



- A Green indicator diode
- B Yellow indicator diode
- C Optical axis
- D Teach button
- E Mounting sleeve

2 kHz

0 ... 500 mm

10 - 30 V
DC

- Polarized, laser retro-reflective photoelectric sensor, autocollimation optics
- Trigger sensor for highly transparent bottles (PET and glass)
- Small and compact construction with robust plastic housing, protection class IP 67 for industrial application
- Push-pull output with light/dark switching via teach-in button
- High switching frequency for detection of fast events and small parts
- Laser safety class 1
- Easy adjustment via lockable teach button or teach input

Accessories:

(available separately)

- Mounting systems (BT 3...)
- Cable with M8 or M12 connector (K-D ...)
- Reflectors
- Reflective tape 6

Electrical connection

Plug connection, 4-pin (with/without cable)

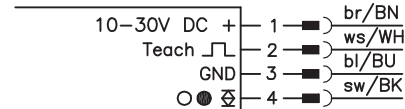

Plug connector, 3-pin

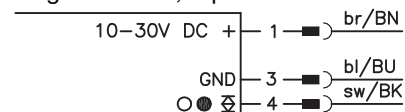

We reserve the right to make changes • DS_PRKL3B6.42_en_50115107.fm

Specifications

Optical data

Typ. operating range limit (tape 6) ¹⁾	0 ... 500mm
Operating range ^{2) 3)}	see tables
Light beam characteristic	collimated, ≤ 3mrad
Light spot diameter	approx. 2mm at optical outlet
Light source ⁴⁾	laser (pulsed)
Wavelength	655nm (visible red light, polarized)
Max. output power	≤ 0.29mW
Pulse duration	5.5µs

Timing

Switching frequency	2000Hz
Response time	0.25ms
Delay before start-up	≤ 300ms

Electrical data

Operating voltage U _B ⁵⁾	10 ... 30VDC (incl. residual ripple)
Residual ripple	≤ 15% of U _B
Open-circuit current	≤ 15mA
Switching output	.../6.42 1 push-pull switching output pin 4: PNP light switching, NPN dark switching pin 2: teach input light/dark reversible
Function characteristics	Signal voltage high/low Output current Operating range
	≥ (U _B -2V)/≤ 2V max. 100mA setting via teach-in

Indicators

Green LED	ready
Yellow LED	light path free
Yellow LED, flashing	light path free, no performance reserve ⁶⁾

Mechanical data

Housing ⁷⁾	plastic (PC-ABS); 1 attachment sleeve, nickel-plated steel
Optics cover	plastic (PMMA)
Weight	with connector: 10g with 200mm cable and connector: 20g with 2m cable: 50g 2m cable (cross section 4x0.20mm ²), connector M8 metal, 0.2m cable with connector M8 or M12
Connection type	

Environmental data

Ambient temp. (operation/storage)	-10°C ... +55°C ⁸⁾ / -30°C ... +70°C
Protective circuit ⁹⁾	2, 3
VDE safety class	III
Protection class	IP 67
Laser class	1 (according to EN 60825-1 and 21 CFR 1040.10 with Laser Notice No. 50)
Standards applied	IEC 60947-5-2
Certifications	UL 508 ⁵⁾

Options

Teach-in input/activation input

Transmitter active/not active	≥ 8V/≤ 2V
Activation/disable delay	≤ 1ms
Input resistance	30kΩ

- 1) Typ. operating range limit: max. attainable range without performance reserve
- 2) Operating range: recommended range with performance reserve
- 3) At a reflector distance of < 50 mm, highly transparent bottle are no longer detected
- 4) Average life expectancy 50,000h at an ambient temperature of 25°C
- 5) For UL applications: for use in class 2 circuits according to NEC only
- 6) Display "no performance reserve" as yellow flashing LED is only available in standard teach setting
- 7) Patent Pending Publ. No. US 7,476,848 B2
- 8) Without mounting max. +50°C, with screw mounting on metal part up to +55°C permissible
- 9) 2=polarity reversal protection, 3=short circuit protection for all transistor outputs

Remarks

Adapter plate:

BT 3.2 (part no. 50103844) for alternate mounting on 25.4 mm hole spacing (Omron E3Z, Sick W100...)

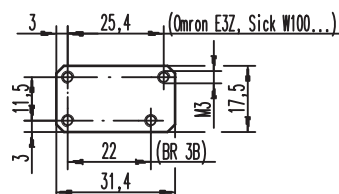

Tables

Reflectors		Operating range ³⁾
1 TK	series 53	0 ... 0.4m
2 REF	6-S-20x40	0 ... 0.4m
3 Tape 6	25x25	0 ... 0.4m

1 0	0.4	0.5
2 0	0.4	0.5
2 0	0.4	0.5

- Operating range [m]
- Typ. operating range limit [m]

- If necessary, reflectors not listed here can be used. Please call our application service hotline for information.

Remarks

- **Approved purpose:**
This product may only be used by qualified personnel and must only be used for the approved purpose. This sensor is not a safety sensor and is not to be used for the protection of persons.
- The devices may only be operated with the devices listed in the table.

Mounting system:



- ① = BT 3 (part no. 50060511)
- ②+③ = BT 3.1 ¹⁾ (part no. 50105585)
- ①+②+③ = BT 3B (part no. 50105546)

1) Packaging unit: PU = 10 pcs.

PRKL 3B Laser-retro-reflective photoel. sensors with polariz. filter for bottles

Order guide

Selection table		Order code →			
Equipment ↓		PRKL 3B/6.42-S8 Part No. 50115117	PRKL 3B/6.42, 200-S8 Part No. 50115118	PRKL 3B/6.42, 200-S12 Part No. 50115119	PRKL 3B/6.42 Part No. 50115116
Switching output	1 x push-pull switching output	●	●	●	●
Switching function	light/dark switching configurable	●	●	●	●
Connection	M8 connector, metal, 4-pin	●			
	M8 connector, metal, 3-pin ¹⁾				
	cable 200mm with M8 connector, 4-pin		●		
	cable 200mm with M12 connector, 4-pin			●	
	2000mm cable, 4-wire				●
Configuration	teach-in via button (lockable) and teach input ¹⁾	●	●	●	●
Indicators	green LED: ready	●	●	●	●
	yellow LED: switching output	●	●	●	●

1) Teach input not present with 3-pin connector

Sensor adjustment (teach) via teach button



- **Prior to teaching:**
Clear the light path to the reflector!
The device setting is stored in a fail-safe way. A reconfiguration following voltage interruption or switch-off is thus not required.

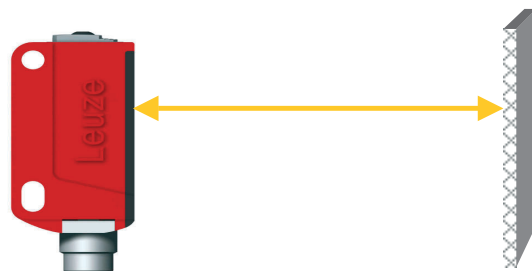

Teach for 11% sensor sensitivity (highly transparent bottles and foils with thickness > 20µm)

- Press teach button until both LEDs flash **simultaneously**.
- Release teach button.
- Ready.



After the teaching, the sensor switches when about 11% of the light beam are covered by the object.

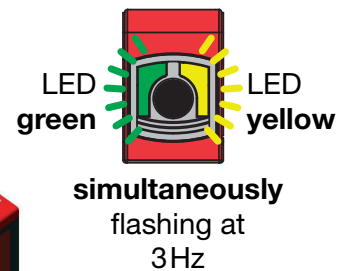
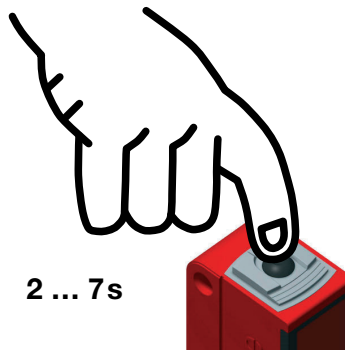

Teach for 18% sensor sensitivity (standard bottles)

- Press teach button until both LEDs flash **alternatingly**.
- Release teach button.
- Ready.



After the teaching, the sensor switches when about 18% of the light beam are covered by the object.

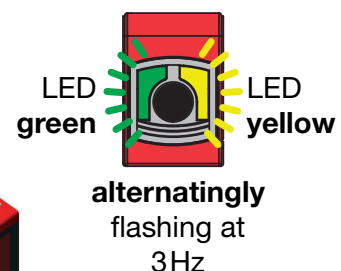
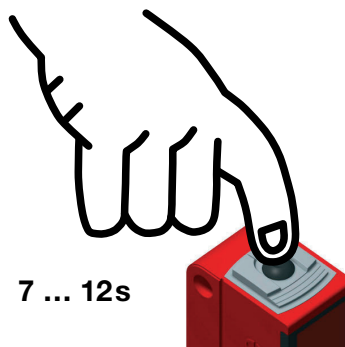

Teaching for maximum operating range (factory setting at delivery)

- Prior to teaching:
Cover the light path to the reflector!
- Press teach button until both LEDs flash **simultaneously**.
- Release teach button.
- Ready.

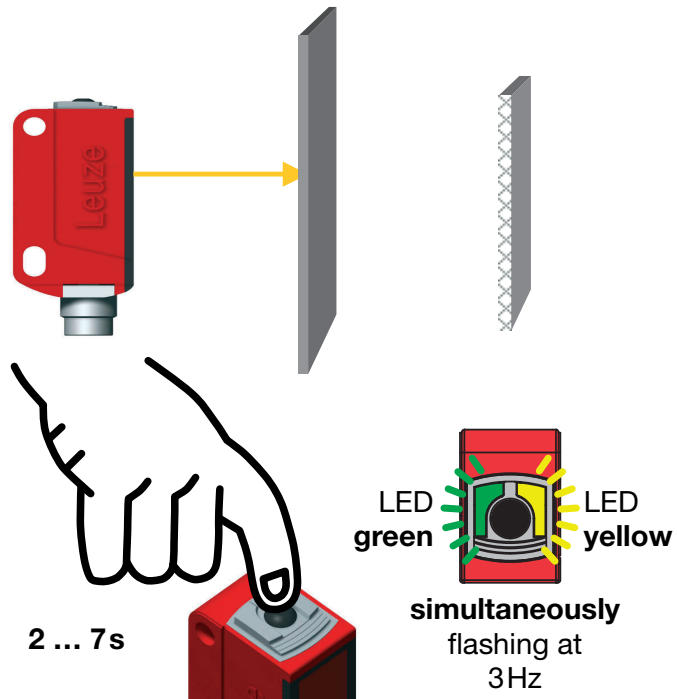

Adjusting the switching behavior of the switching output – light/dark switching

- Press teach button until the green LED flashes. The yellow LED displays the current setting of the switching output:
ON = output switches on light
OFF = output switches on dark
- Continue to press the teach button in order to change the switching behavior.
- Release teach button.
- Ready.

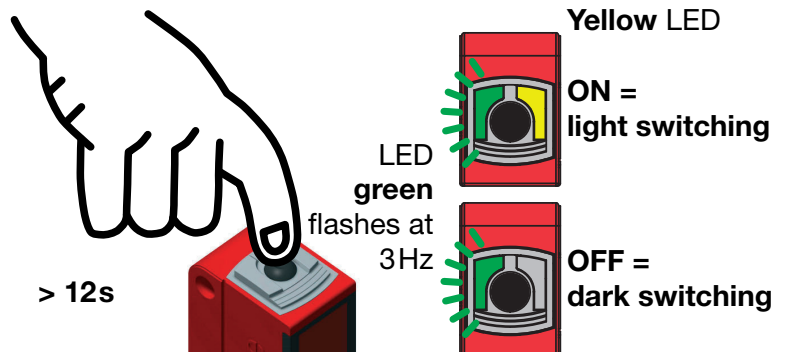

Locking the teach button via the teach input



A **static HIGH signal** (≥ 4 ms) at the teach input locks the teach button on the device if required, such that no manual operation is possible (e.g., protection from erroneous operation or manipulation).

If the teach input is not connected or if there is a static low signal, the button is unlocked and can be operated freely.



PRKL 3B Laser-retro-reflective photoel. sensors with polariz. filter for bottles

Sensor adjustment (teach) via teach input



The following description applies to PNP switching logic!

$U_{\text{Teach low}} \leq 2\text{V}$

$U_{\text{Teach high}} \geq (U_B - 2\text{V})$

Prior to teaching: Clear the light path to the reflector!

The device setting is stored in a fail-safe way. A reconfiguration following voltage interruption or switch-off is thus not required.

Teach for 11% sensor sensitivity
(highly transparent bottles and foils with thickness > 20µm)

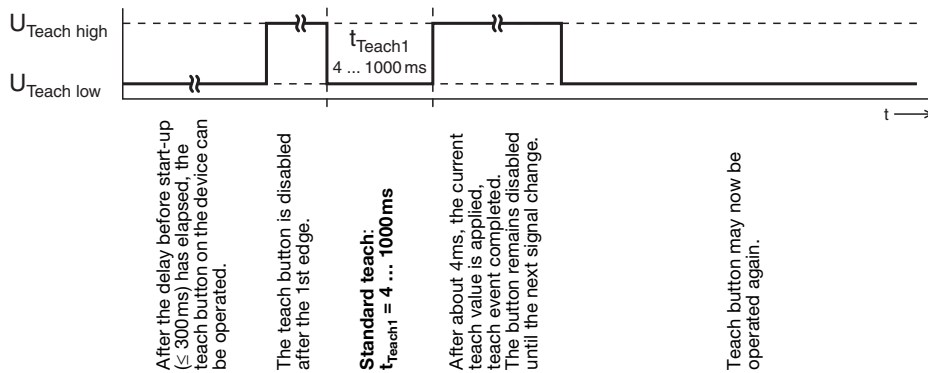

Quick teach for 11% sensor sensitivity
(highly transparent bottles and foils with thickness > 20µm)

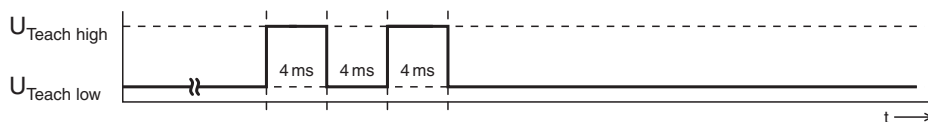

shortest teaching duration for standard teaching: approx. 12ms



After teaching for 11% sensor sensitivity, the sensor switches for objects with a minimum size of 1 mm.

Teach for 18% sensor sensitivity (standard bottles)

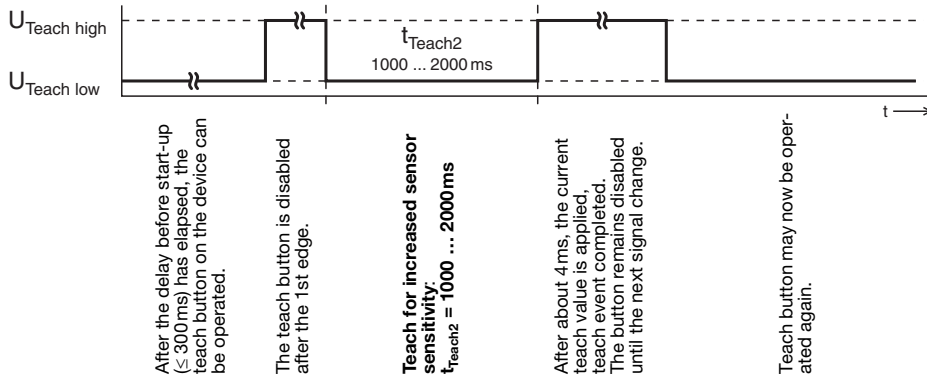

After teaching for 18% sensor sensitivity, the sensor switches for objects with a minimum size of 0.1 mm ... 0.2mm.

Adjusting the switching behavior of the switching output – light/dark switching

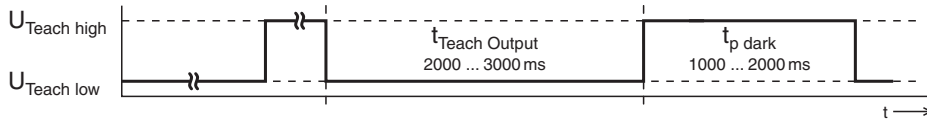
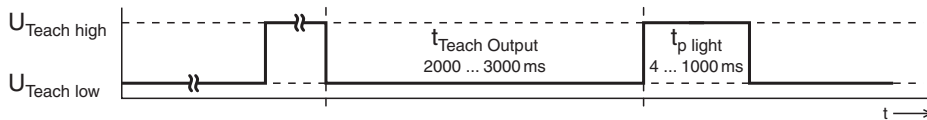

After the delay before start-up (≤ 300ms) has elapsed, the teach button on the device can be operated.

The teach button is disabled after the 1st edge.

Setting the switching behavior of the switching output:
 $t_{\text{Teach Output}} = 2000 \dots 3000 \text{ ms}$

Switching output switches on light:
 $t_{\text{p light}} = 4 \dots 1000 \text{ ms}$

Switching output switches on dark:
 $t_{\text{p dark}} = 1000 \dots 2000 \text{ ms}$

The button remains disabled until the next signal change.